

Barton Creek Residence

Austin TX

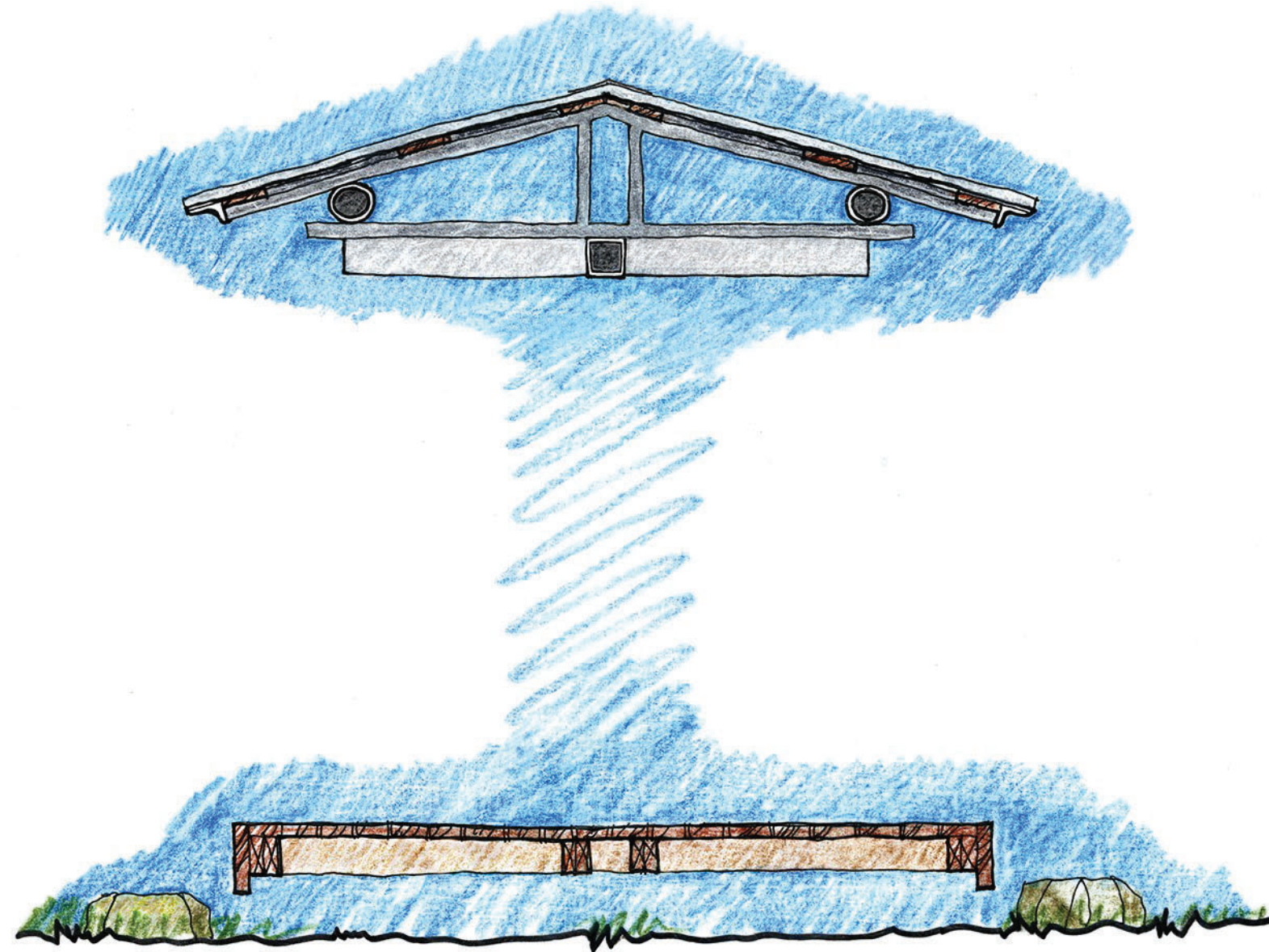

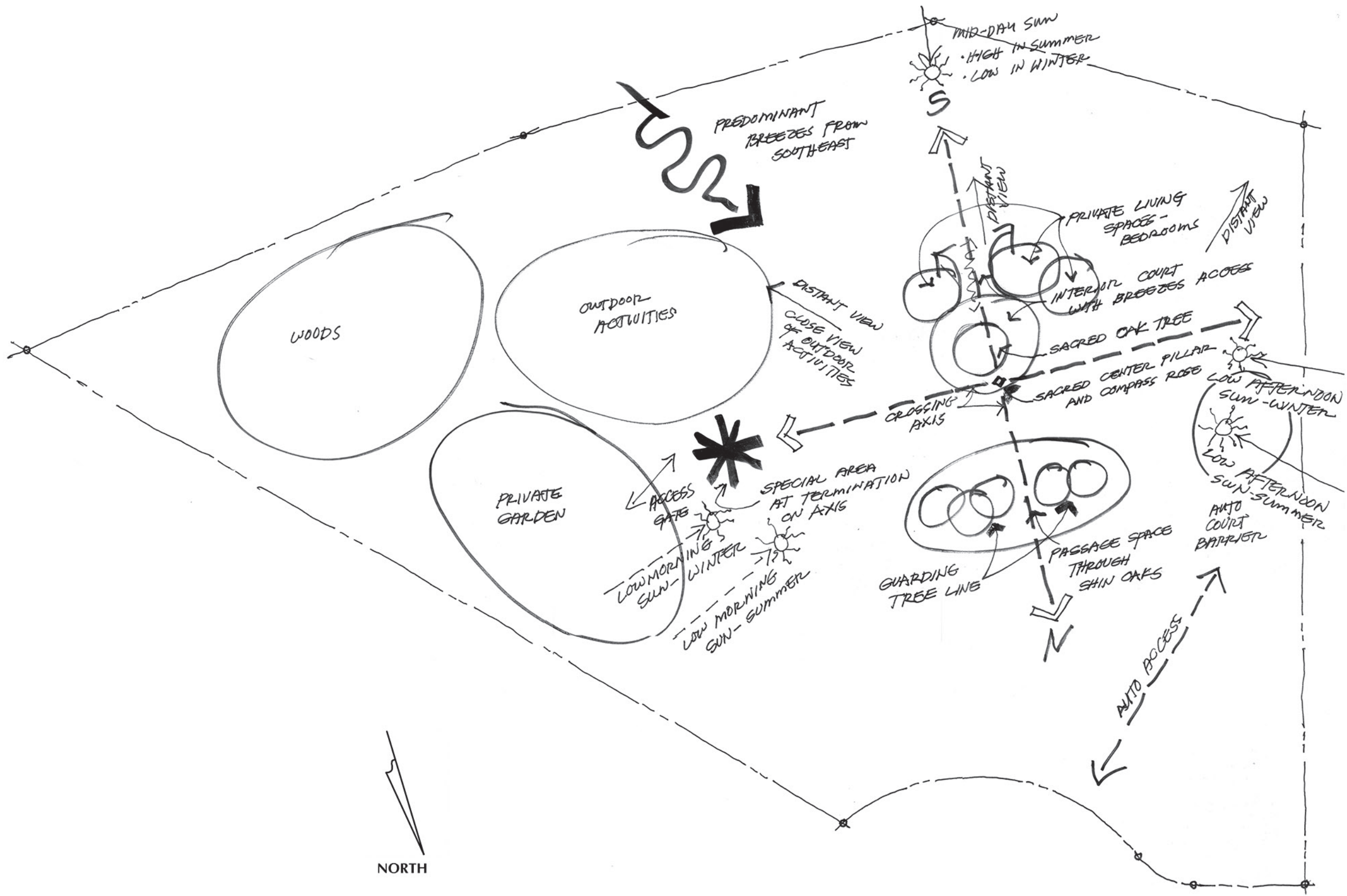

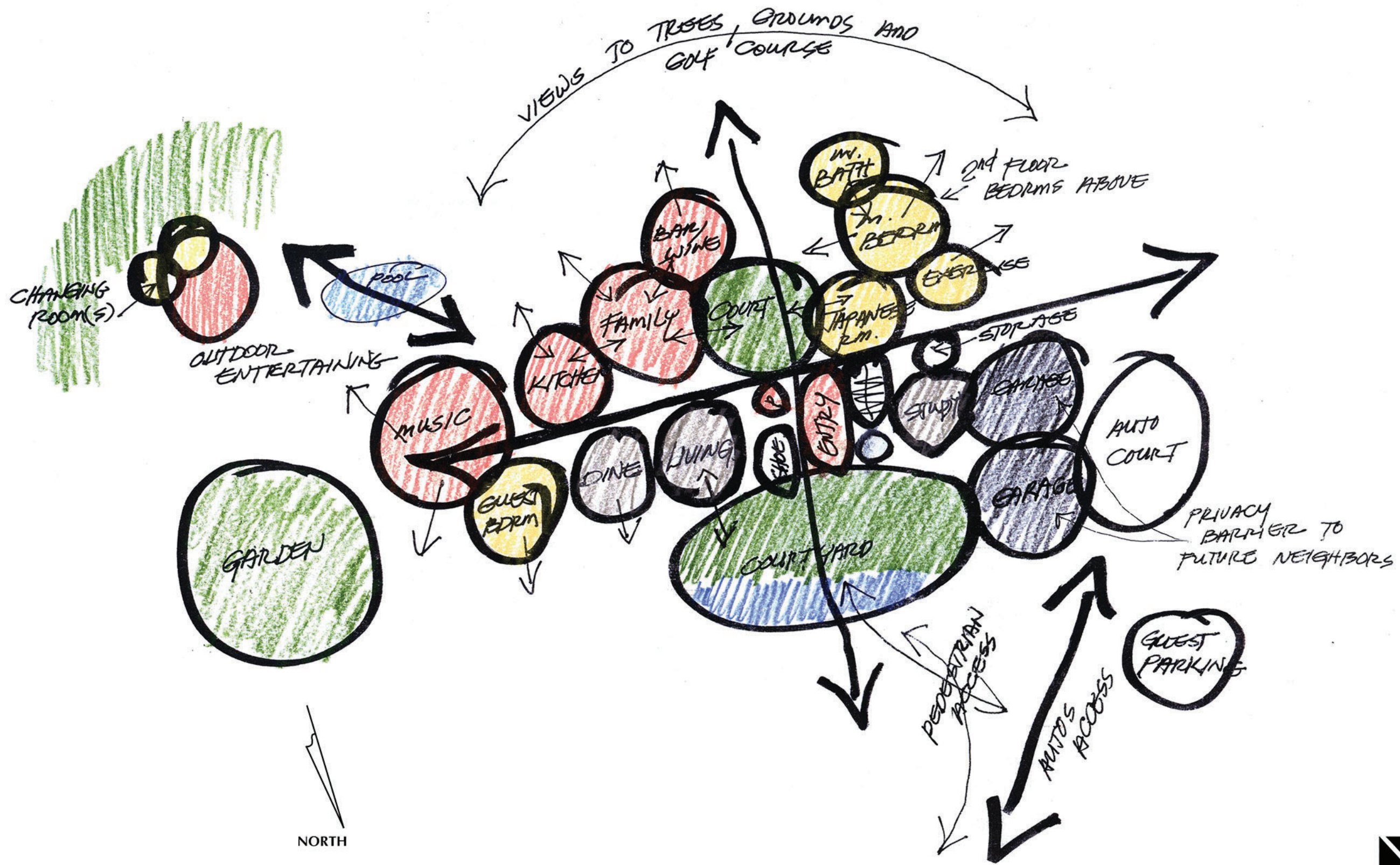



NIX GROUP
ARCHITECTS

BARTON CREEK RESORT
AND CLUB

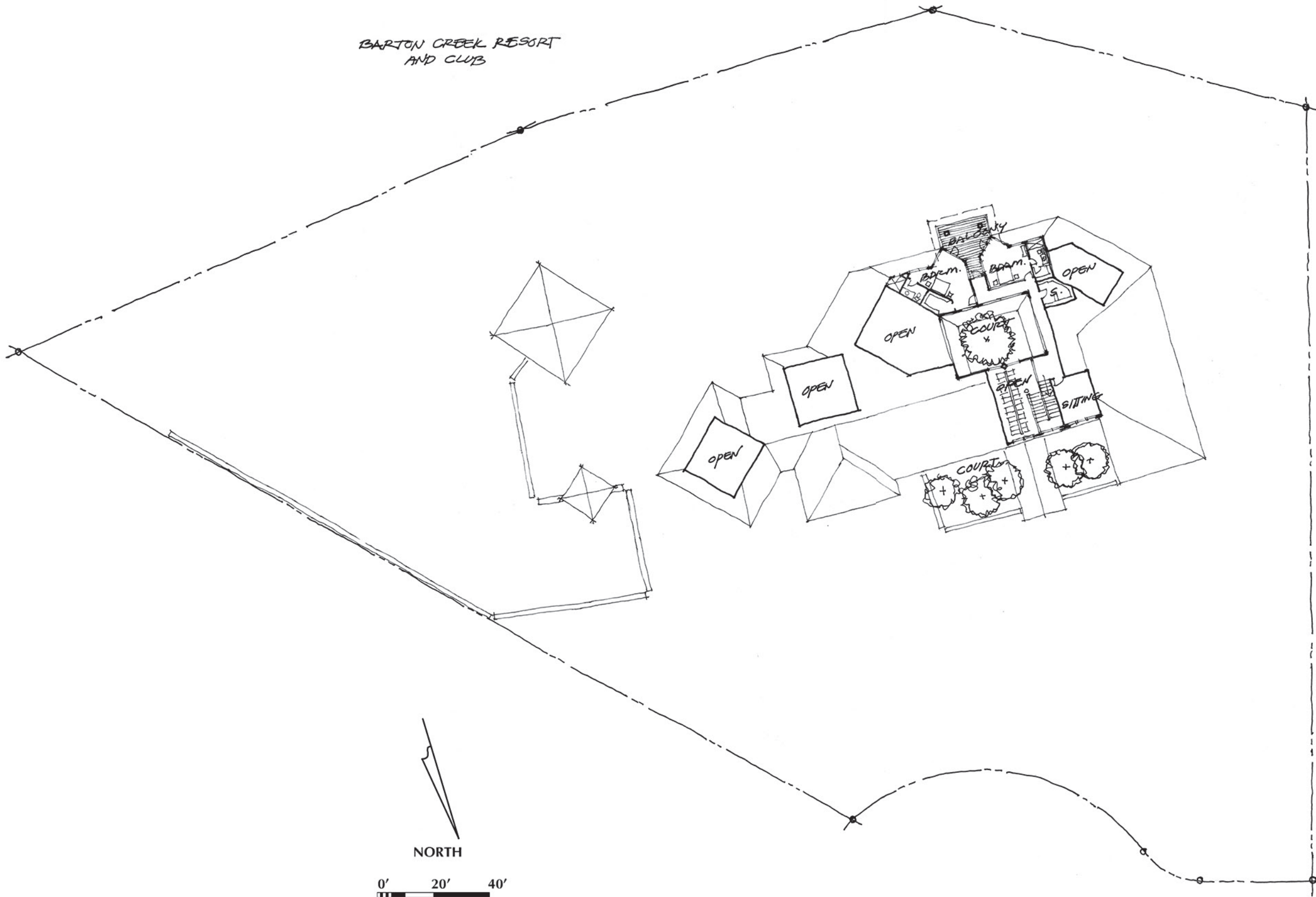

NIX GROUP
ARCHITECTS

BARTON CREEK RESORT
AND CLUB

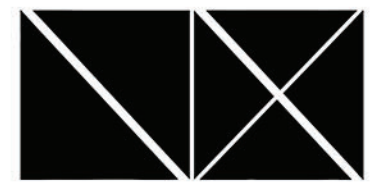
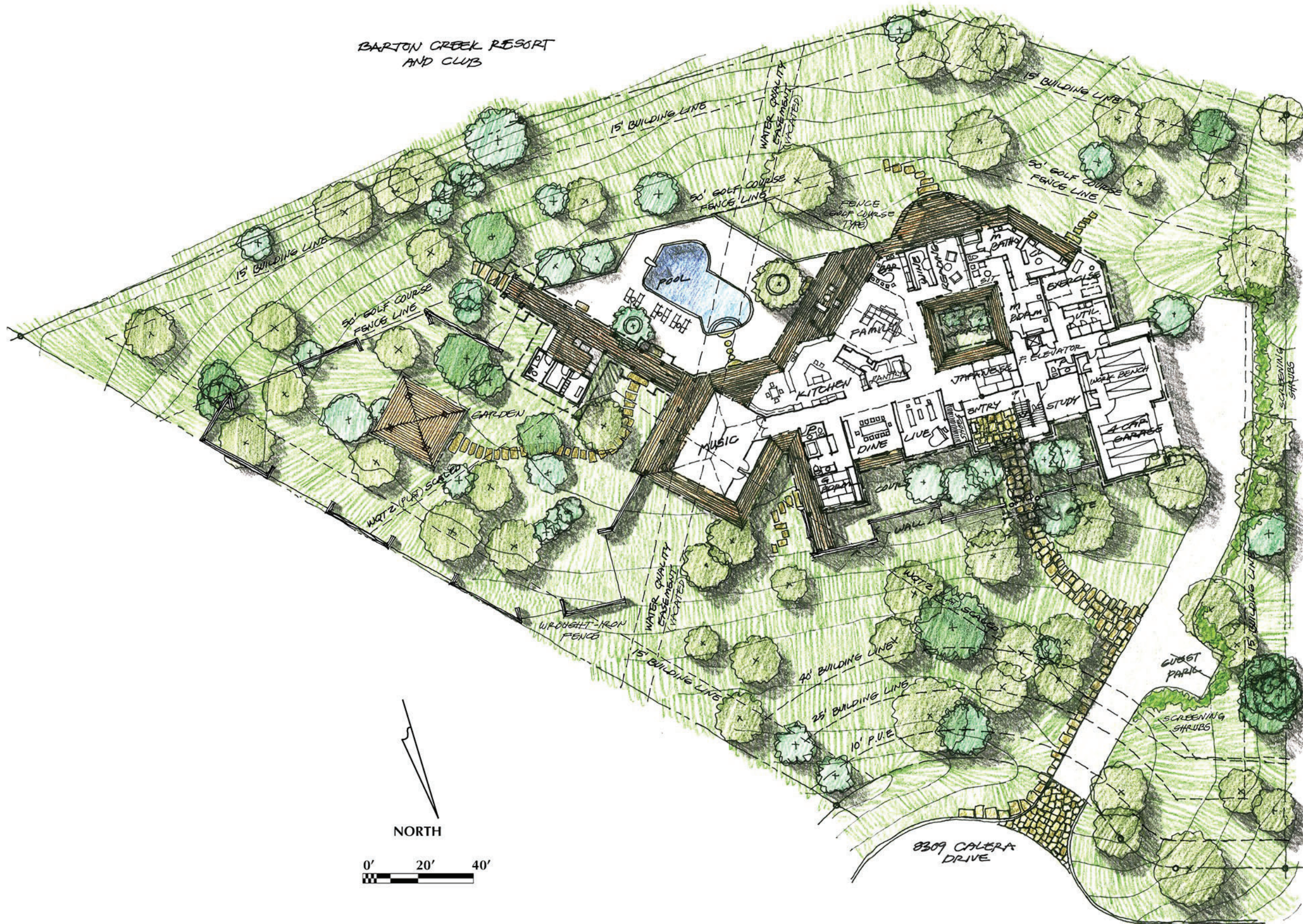

NIX GROUP
ARCHITECTS

BARTON CREEK RESORT
AND CLUB

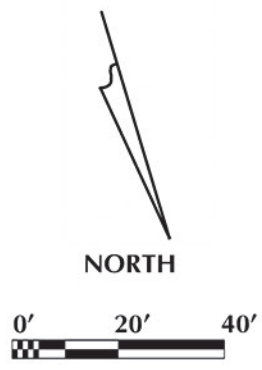
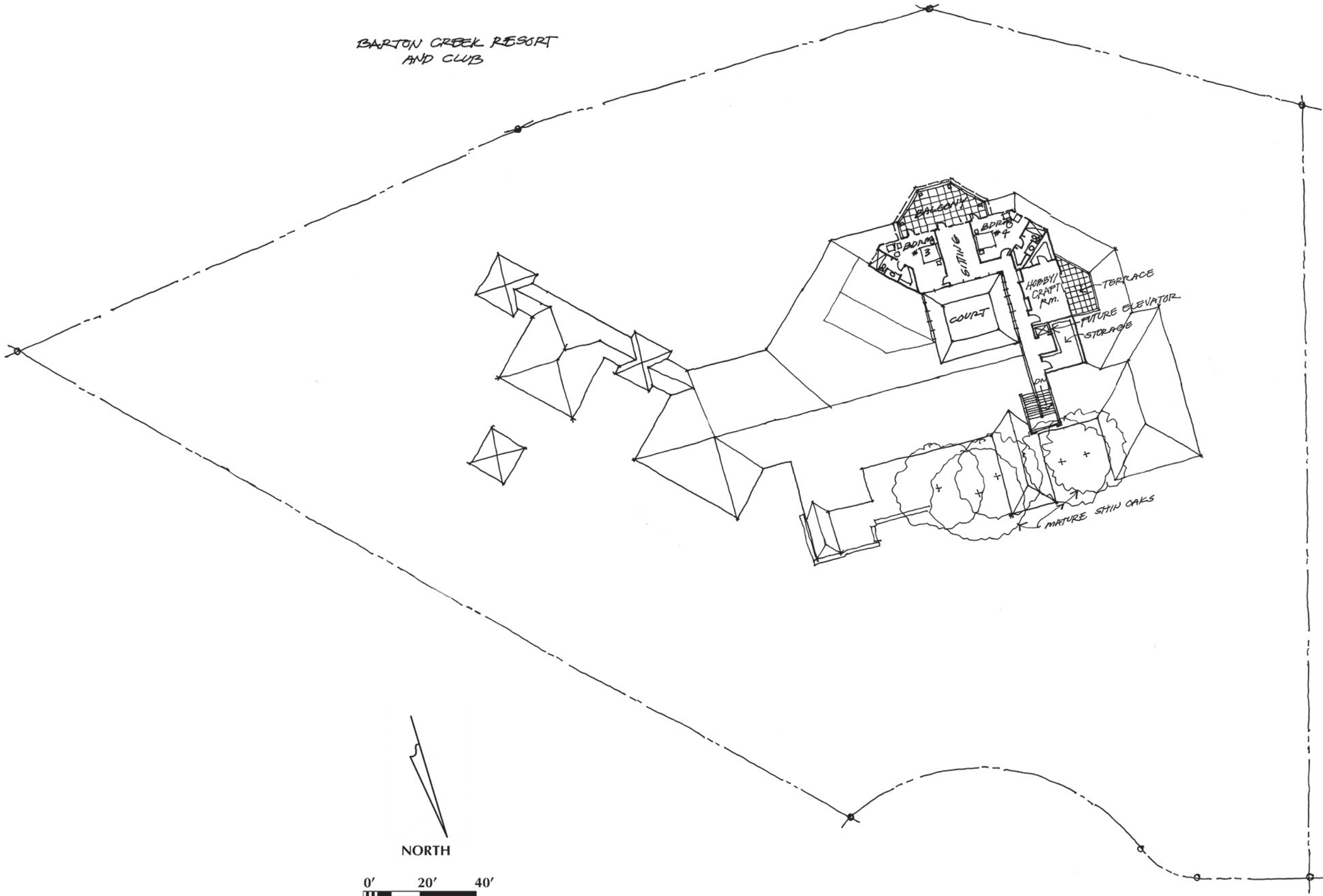

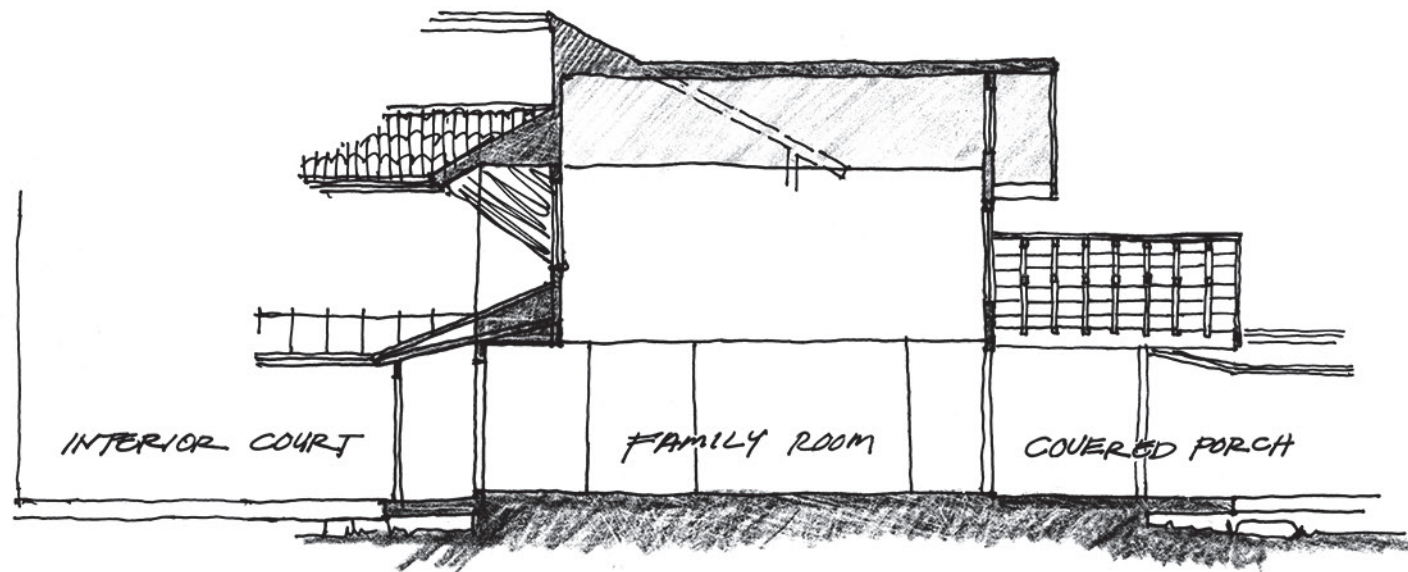

SECTION #4

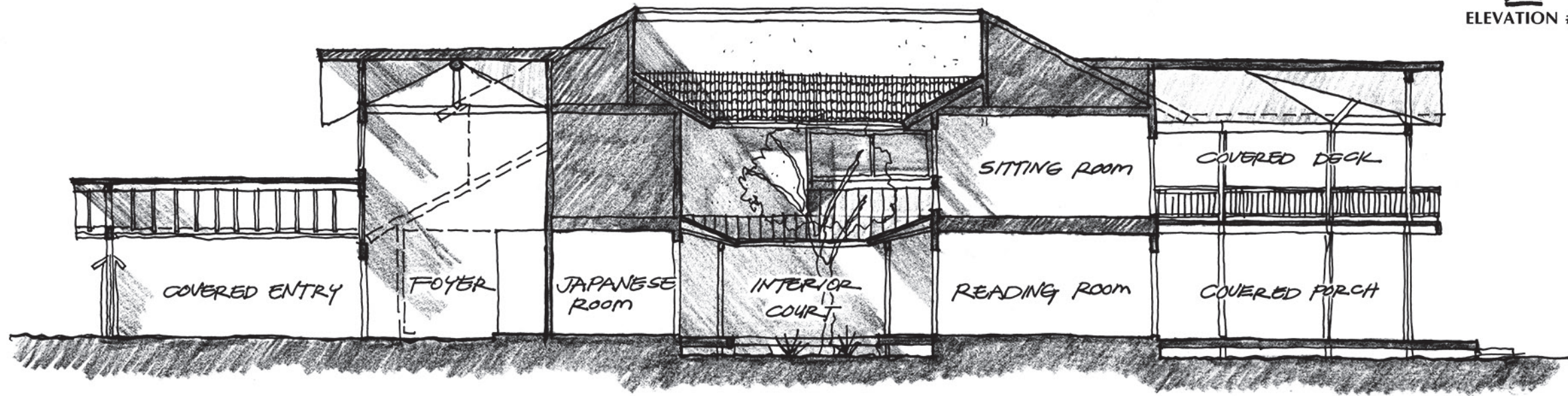
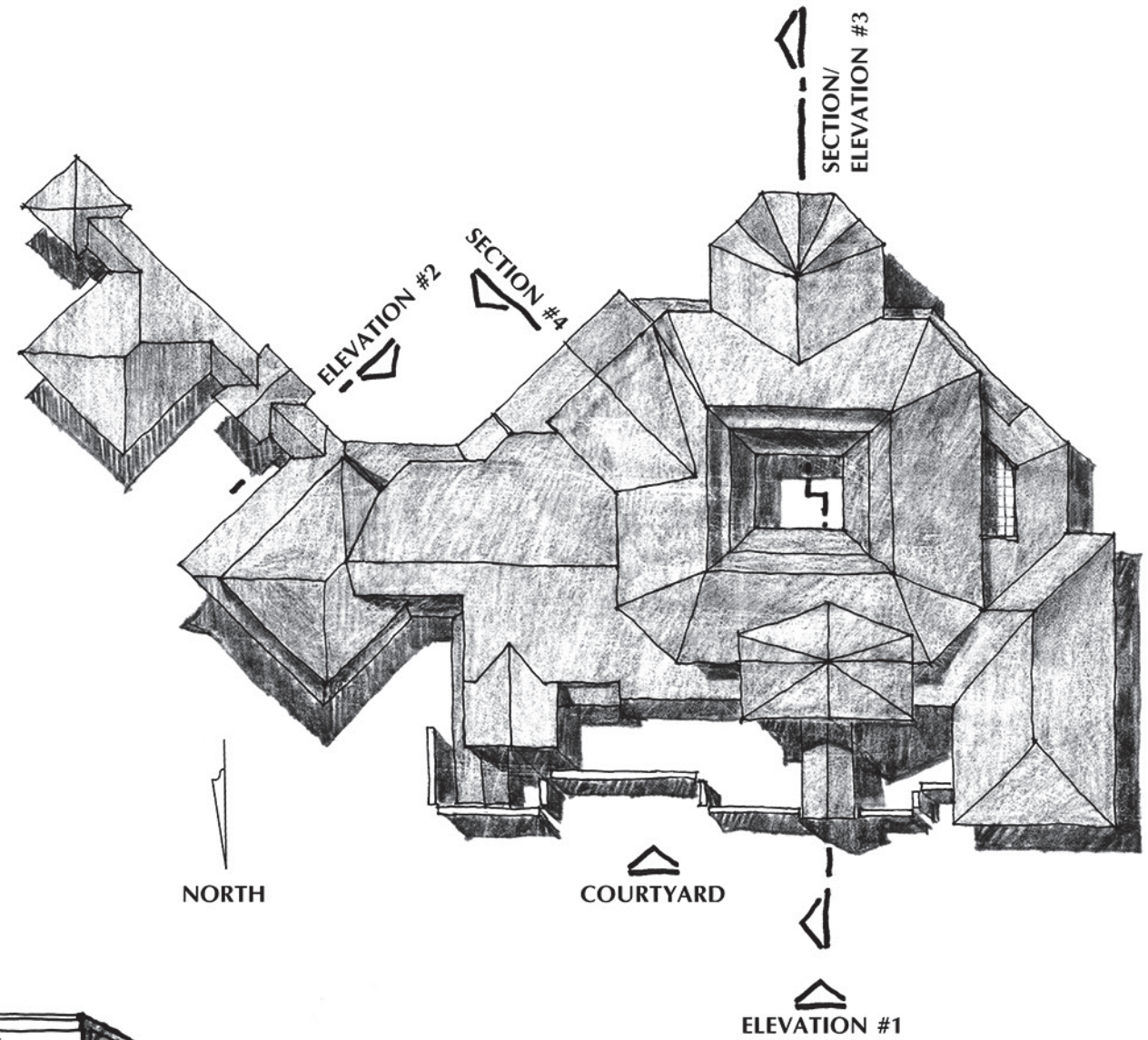

SECTION/ ELEVATION- #3

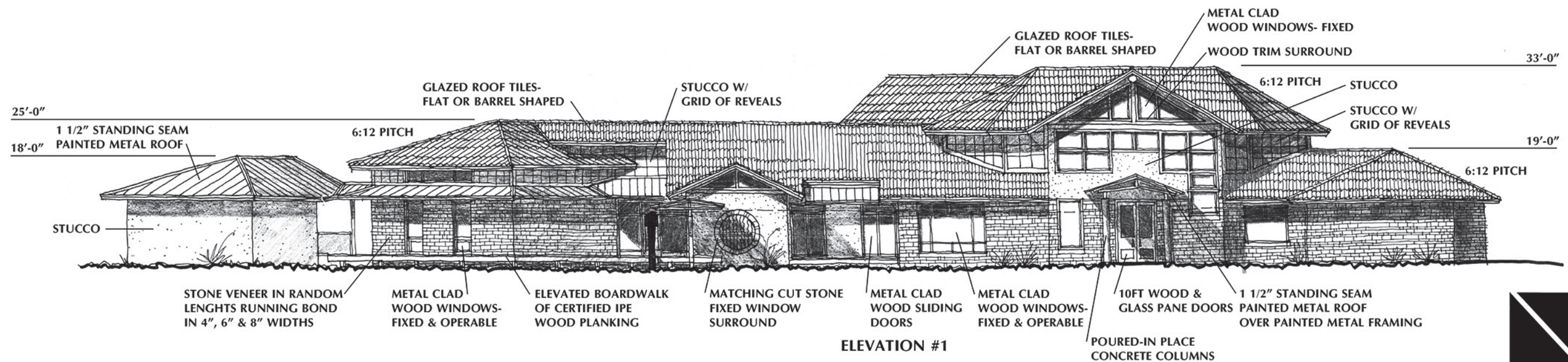
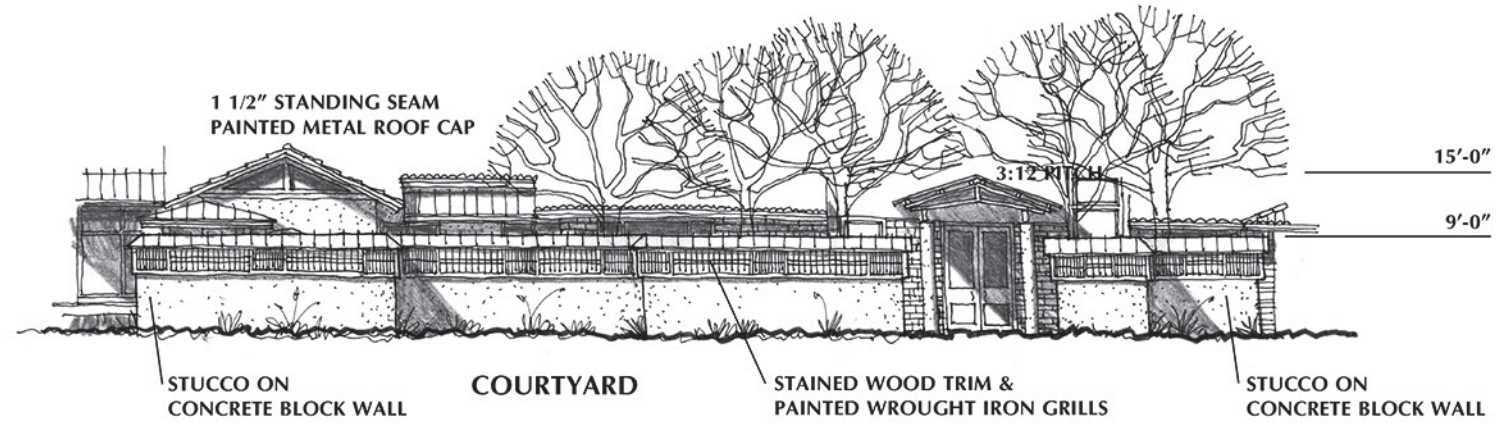
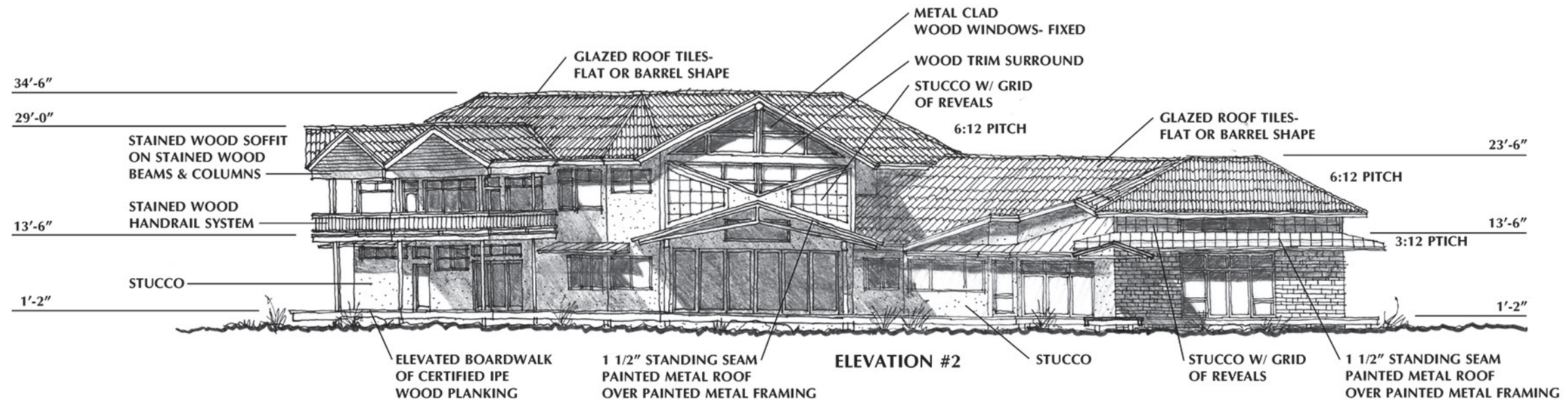

NIX GROUP
ARCHITECTS



NIX GROUP
ARCHITECTS

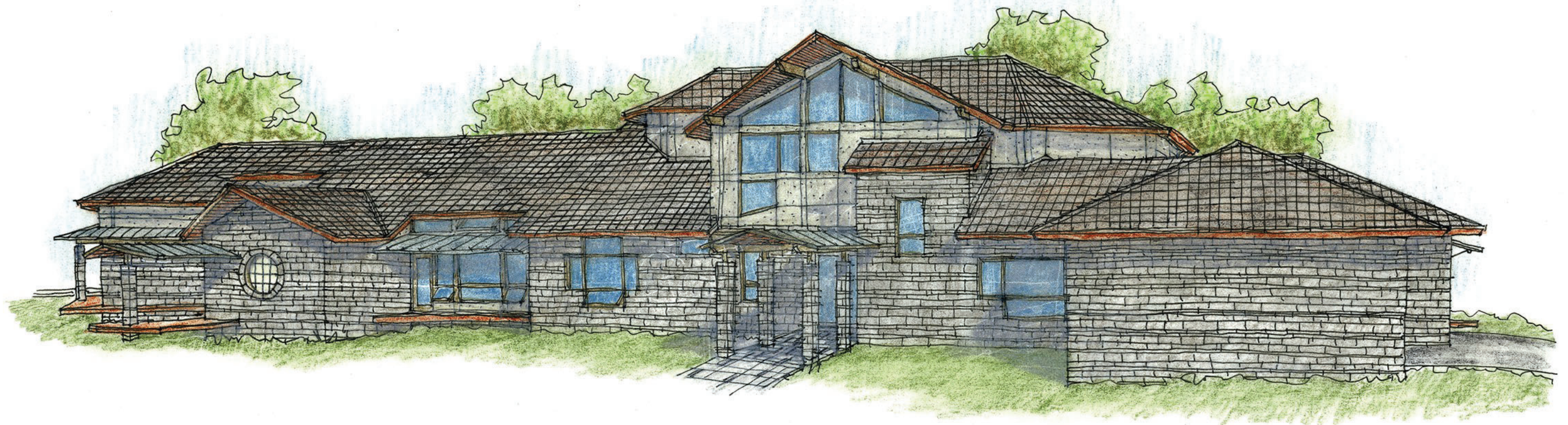

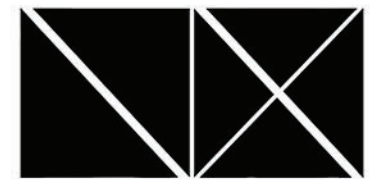
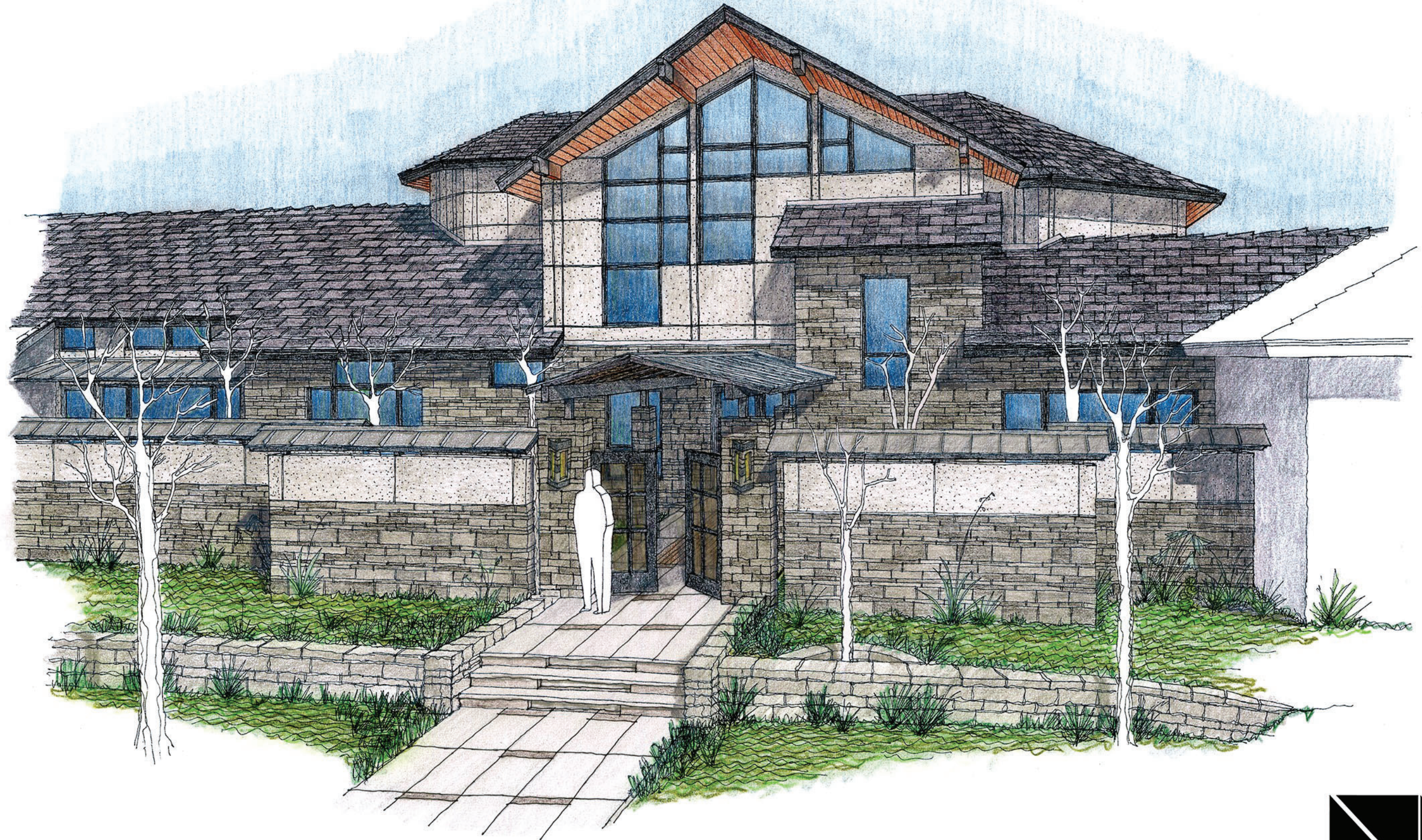

NIX GROUP
ARCHITECTS

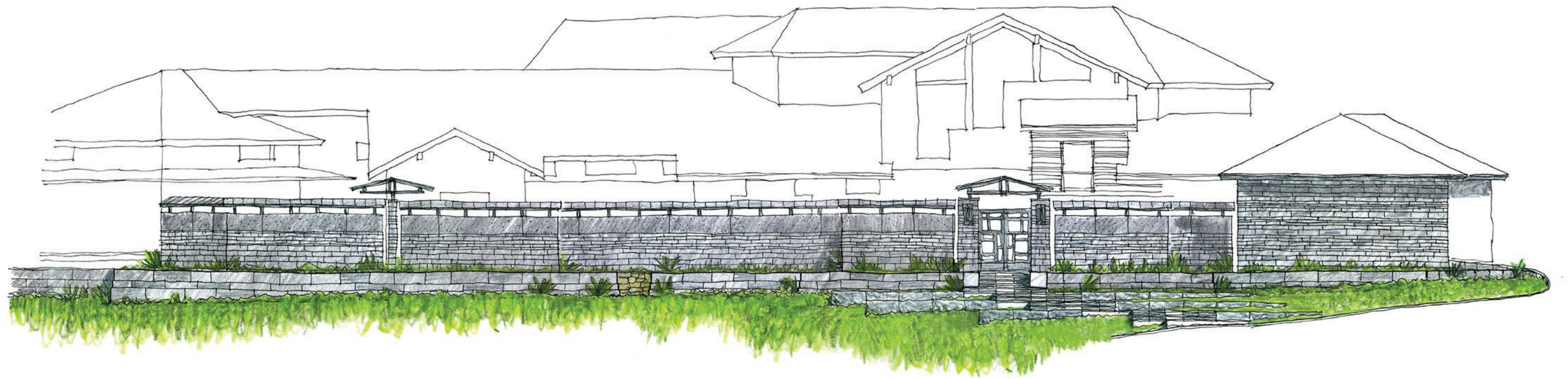

NIX GROUP
ARCHITECTS

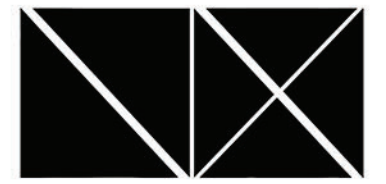
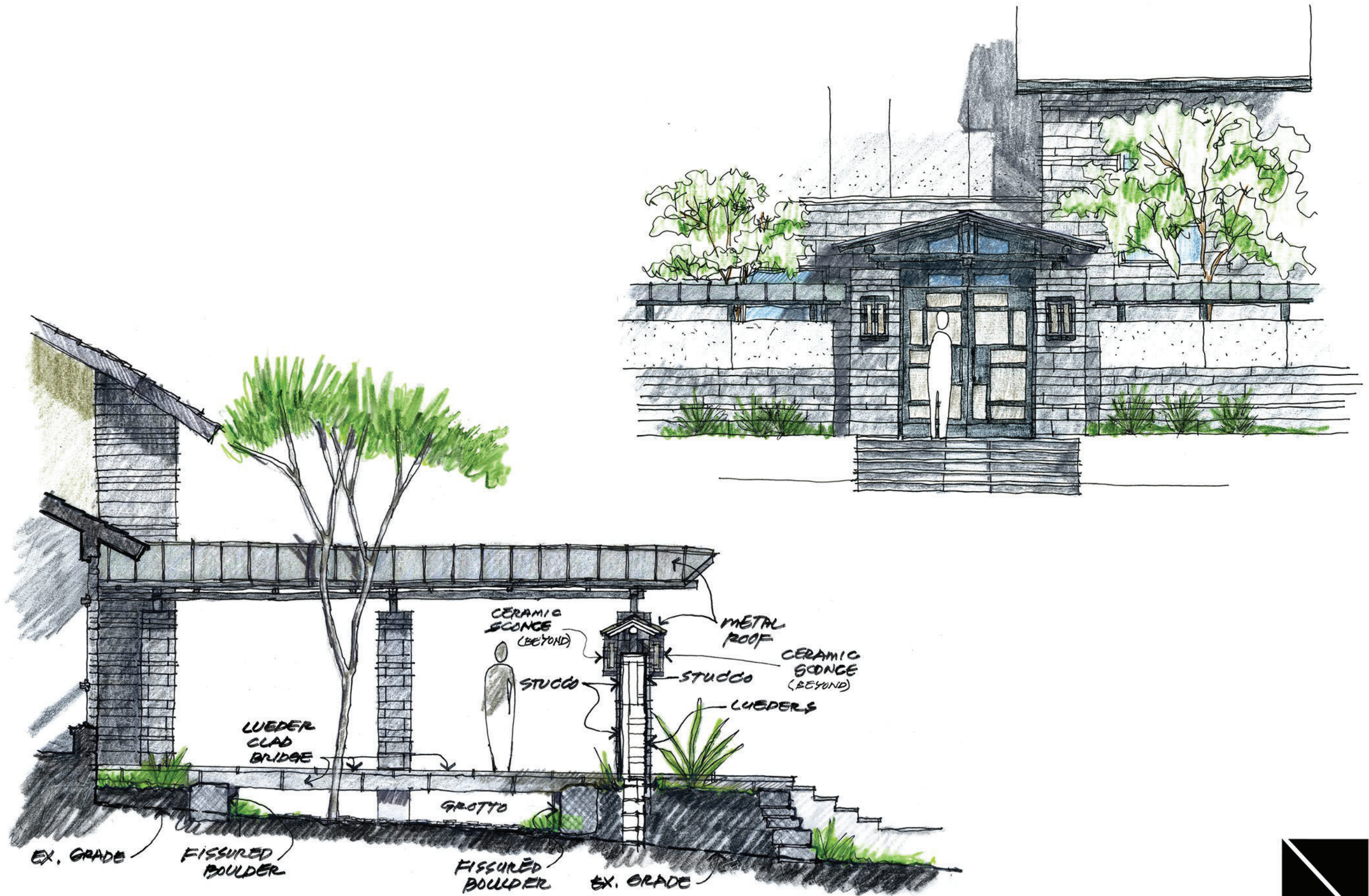

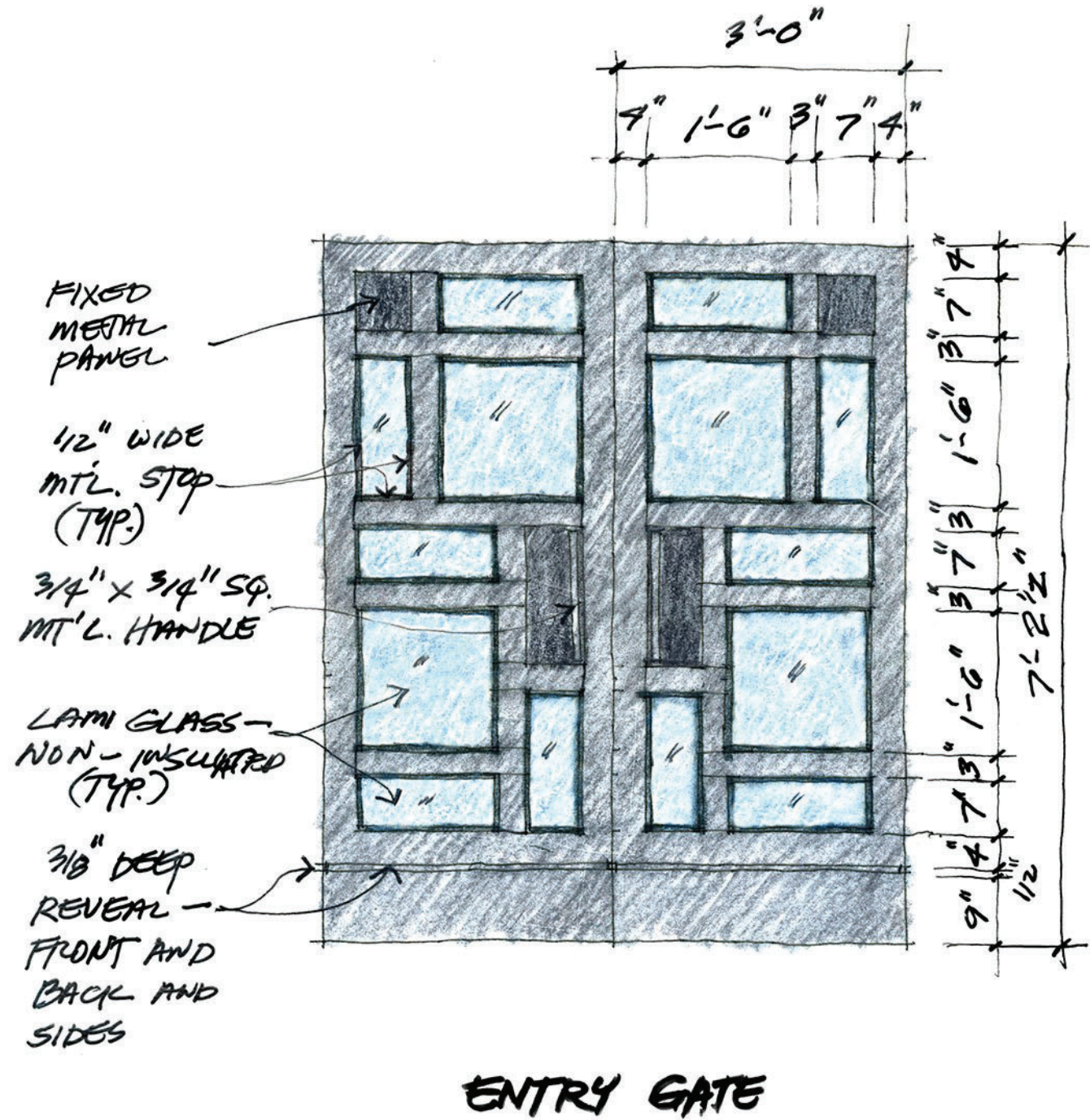
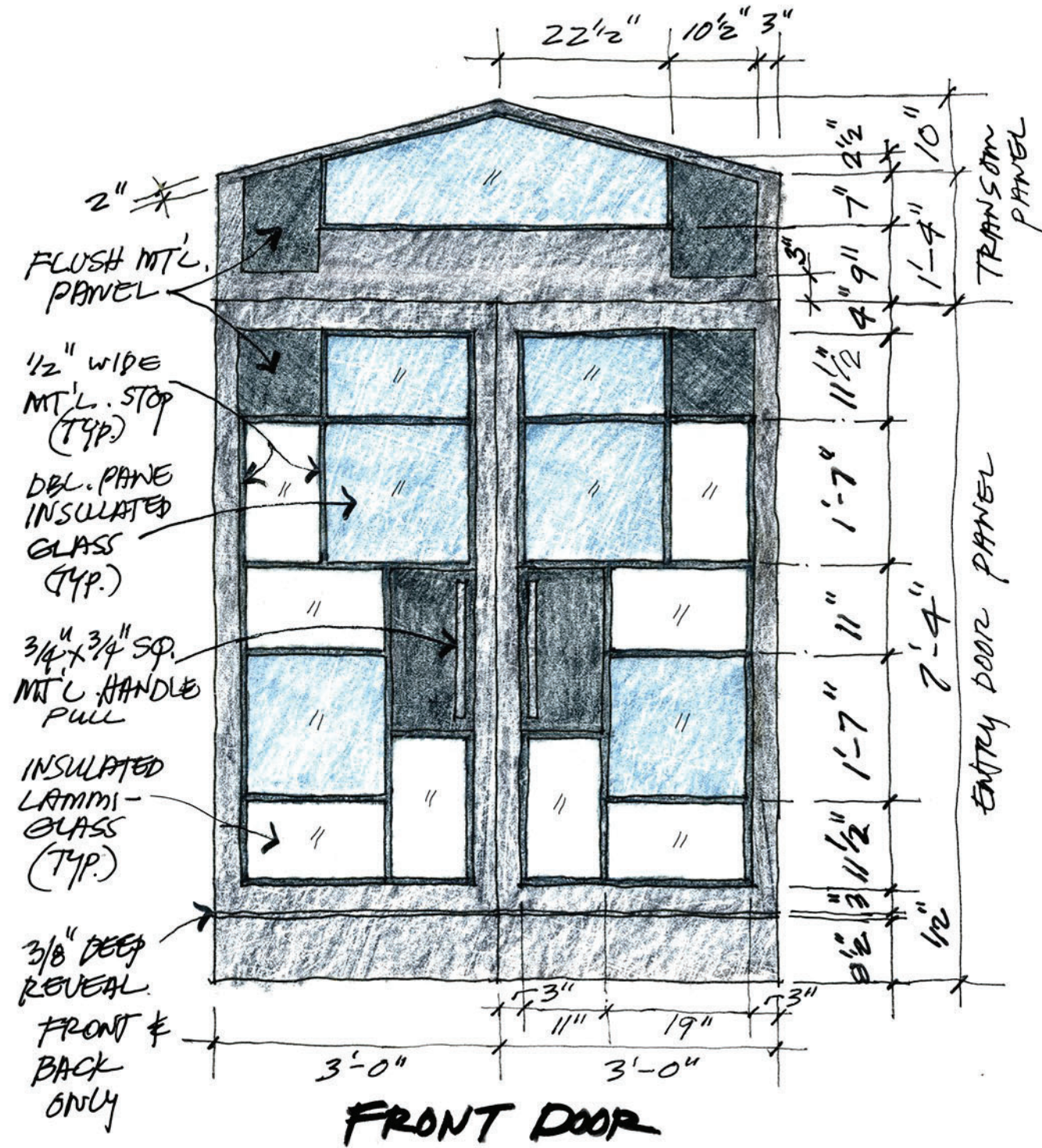

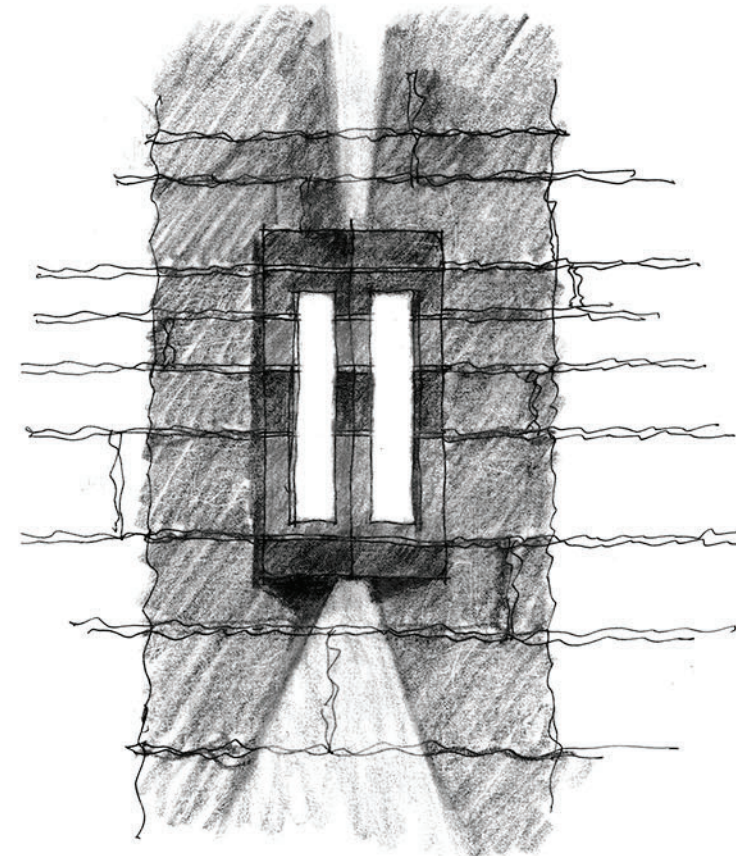
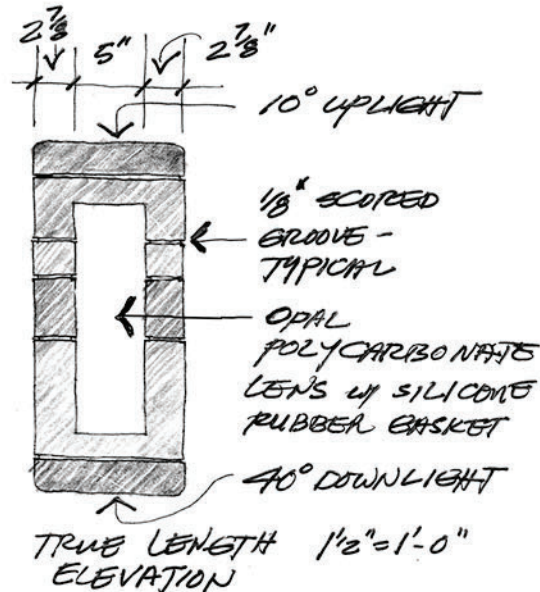
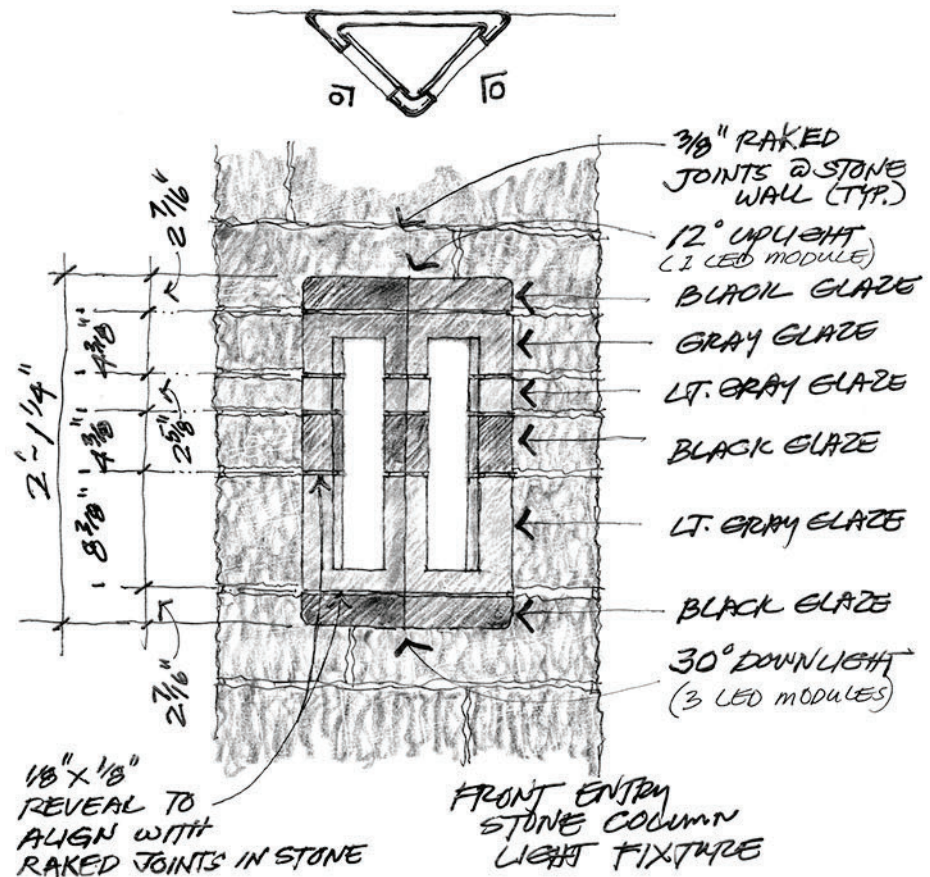

1/8" x 1/8" REVEAL TO ALIGN WITH RAKED JOINTS IN STONE

FRONT ENTRY STONE COLUMN LIGHT FIXTURE

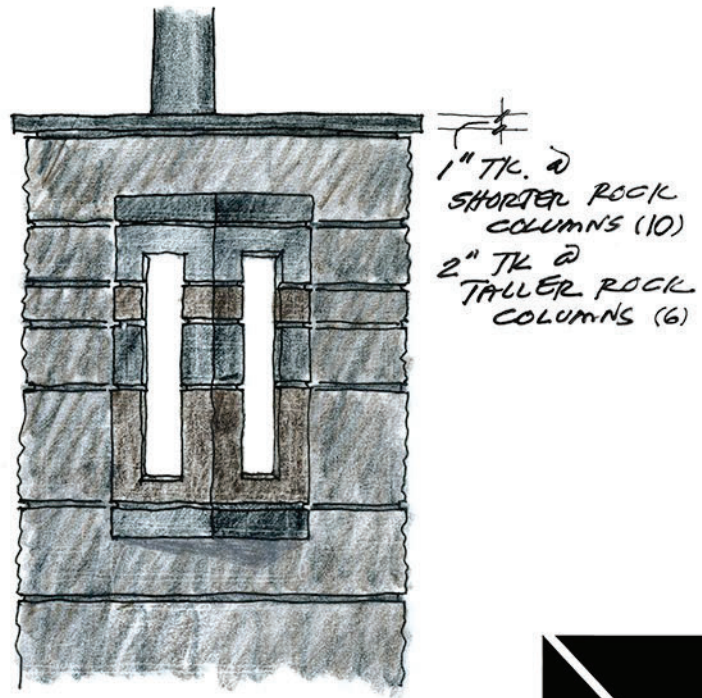
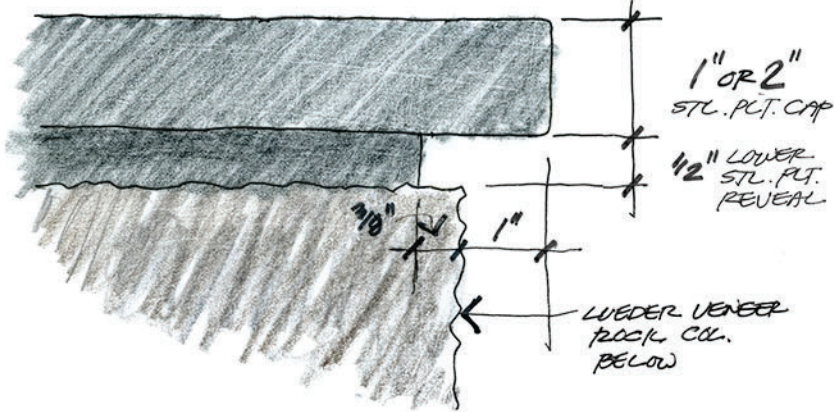
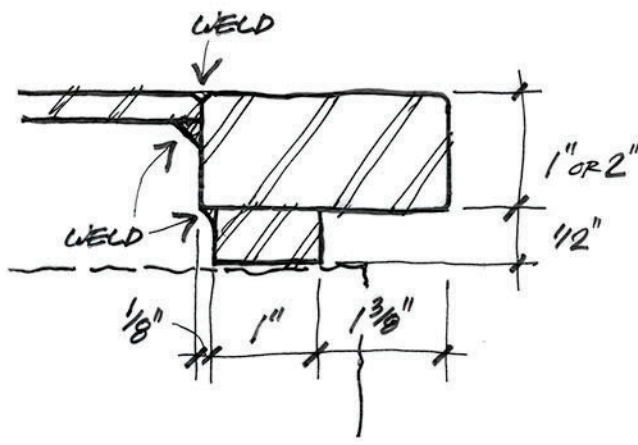
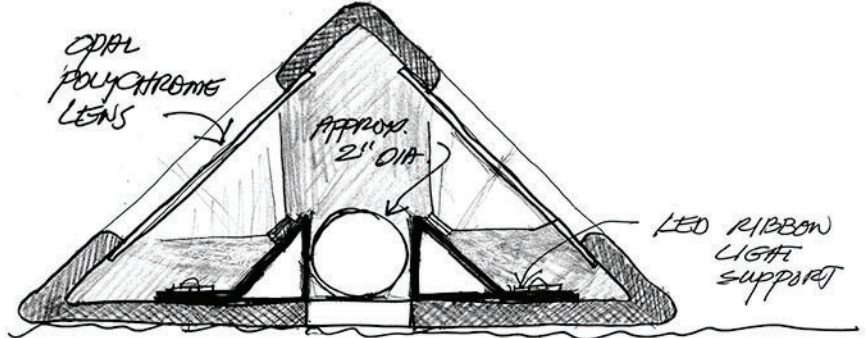

STL. COL. ANNING SUPPORT ABOVE

FRONT EDGE OF 1/2\"/>

REAR EDGE OF 1/2\"/>

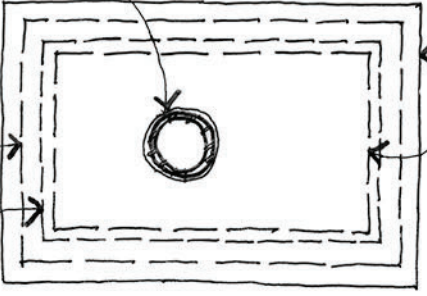

FRONT EDGE OF 1\"/>

REAR EDGE OF 1\"/>



NIX GROUP ARCHITECTS

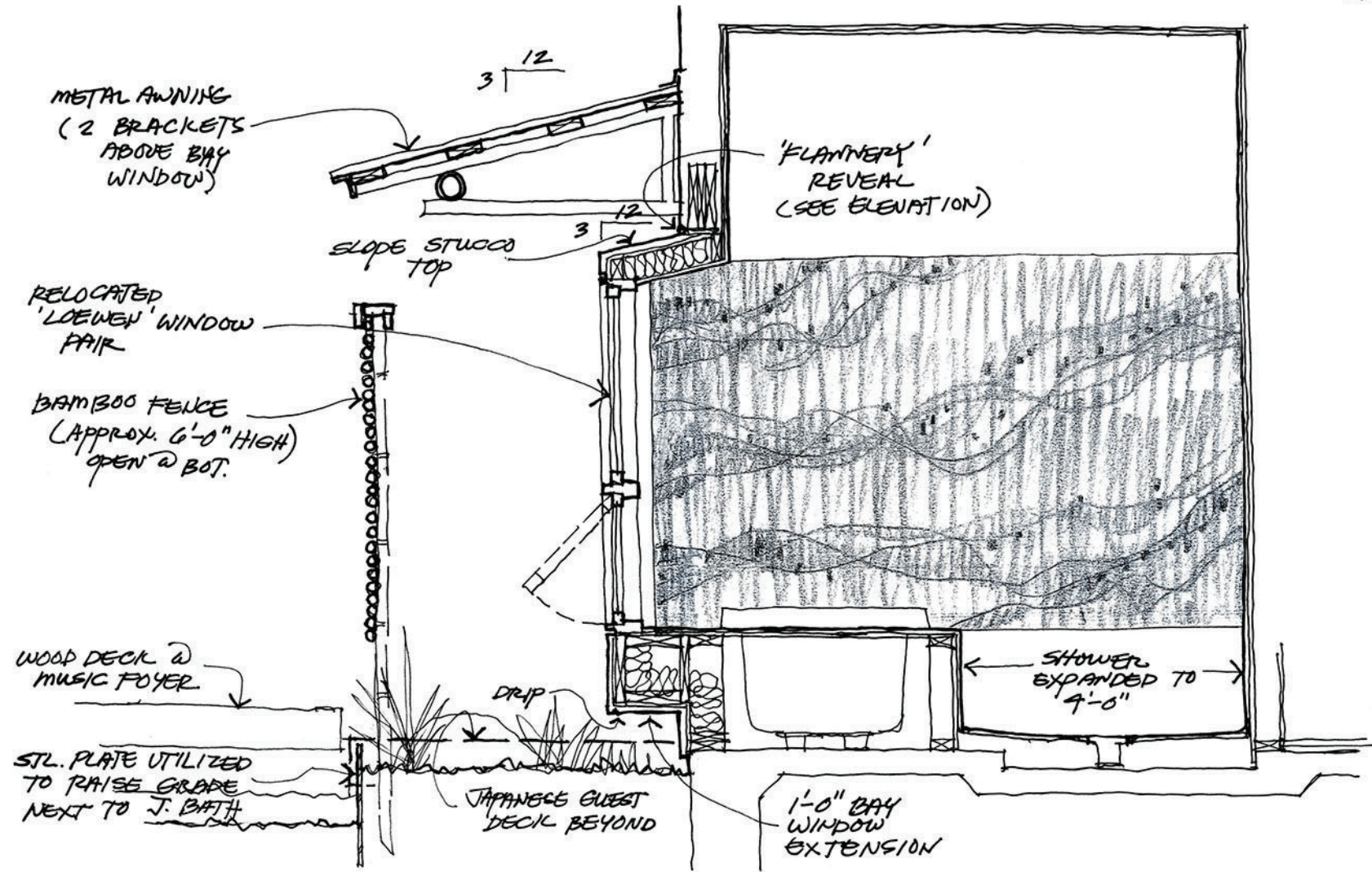
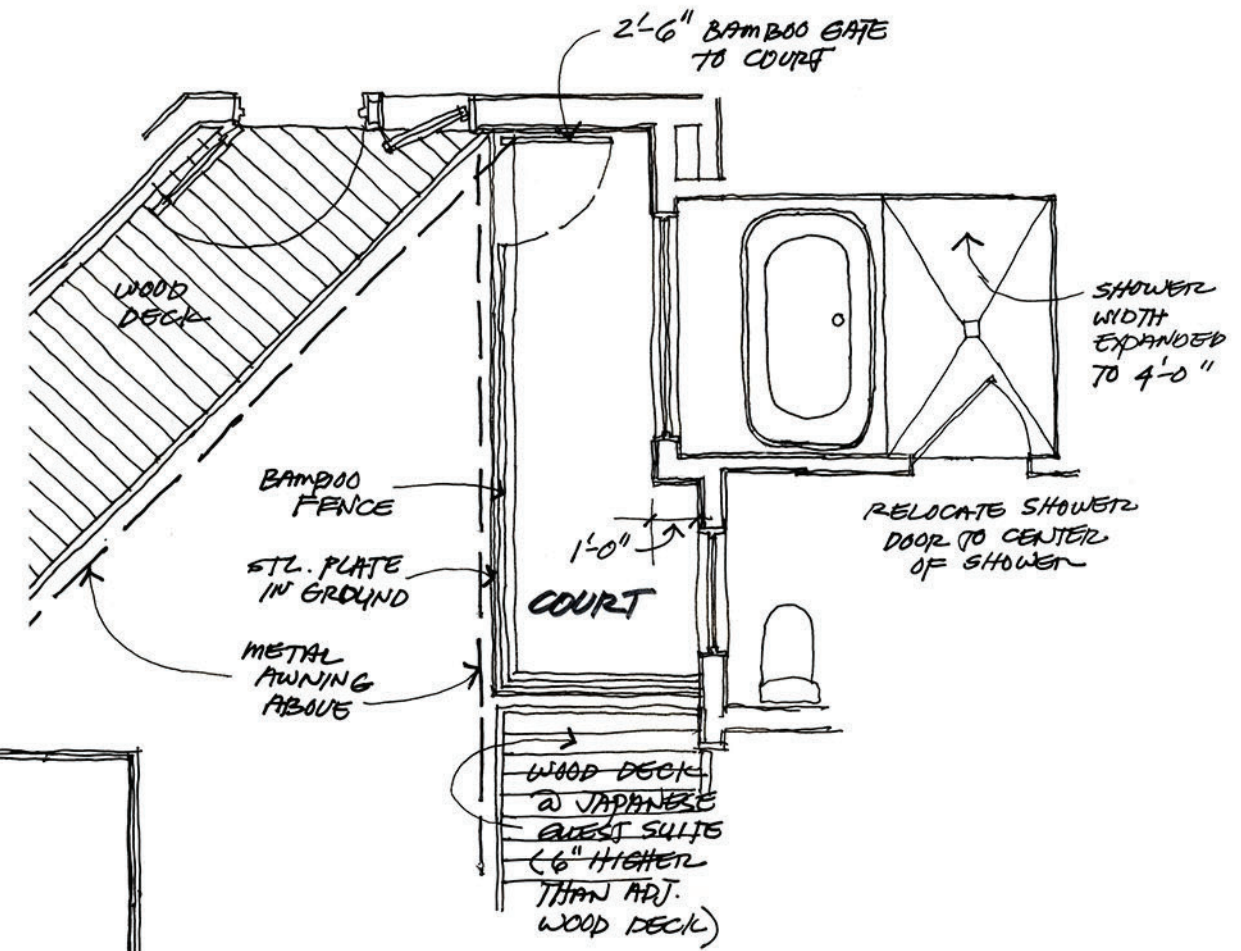

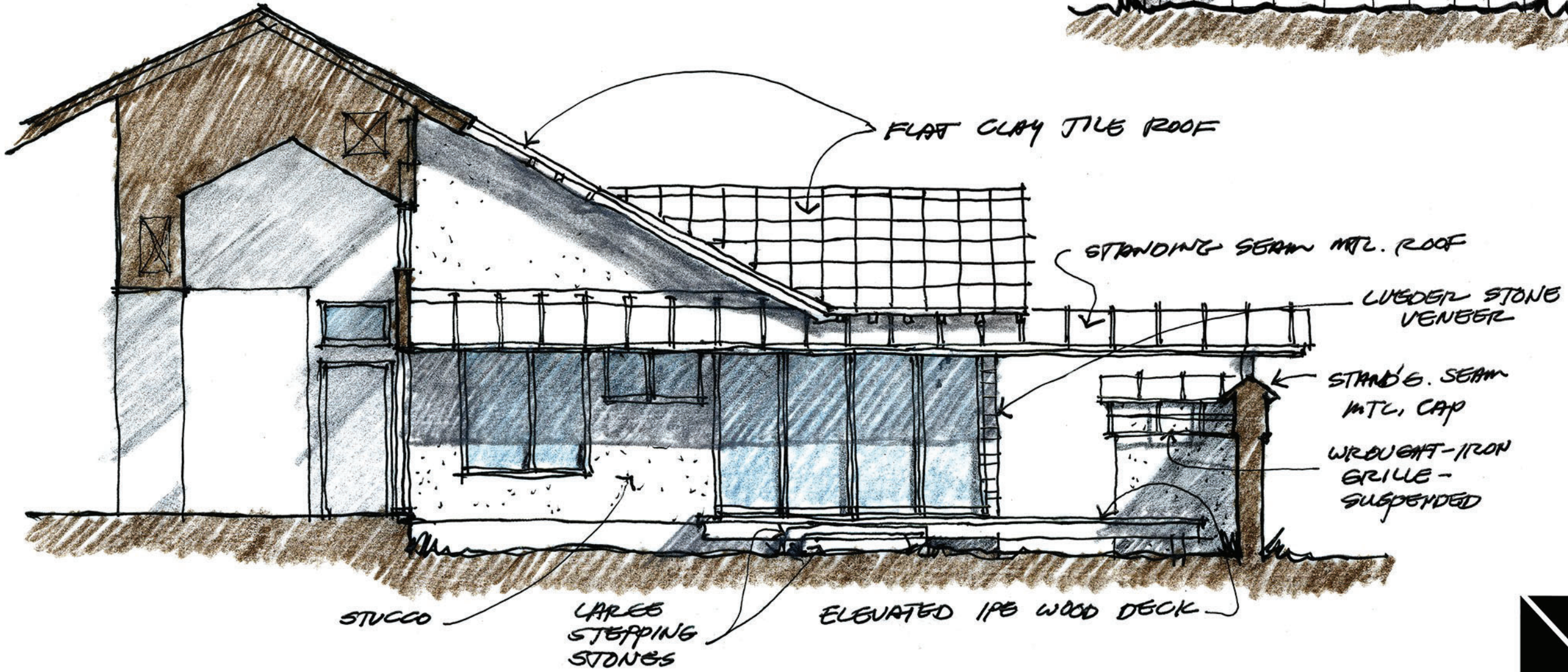

STUCCO

LARER
STEPPING
STONES

ELEVATED IPE WOOD DECK

FLAT CLAY TILE ROOF

STANDING SEAM METL. ROOF

LUDER STONE
VENEER

STAND'S. SEAM
METL. CAP

WROUGHT-IRON
GRILLE -
SUSPENDED



NIX GROUP
ARCHITECTS

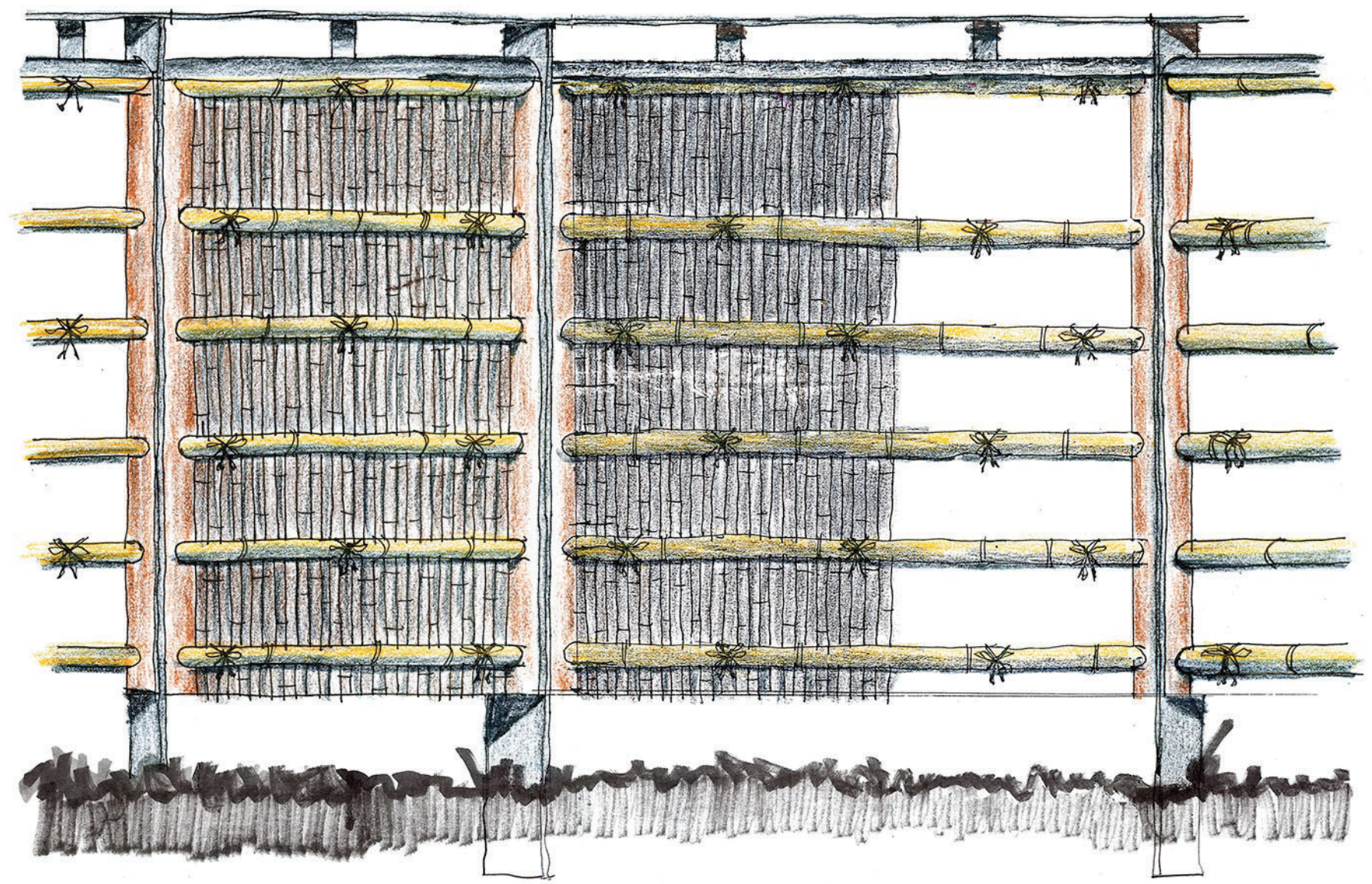
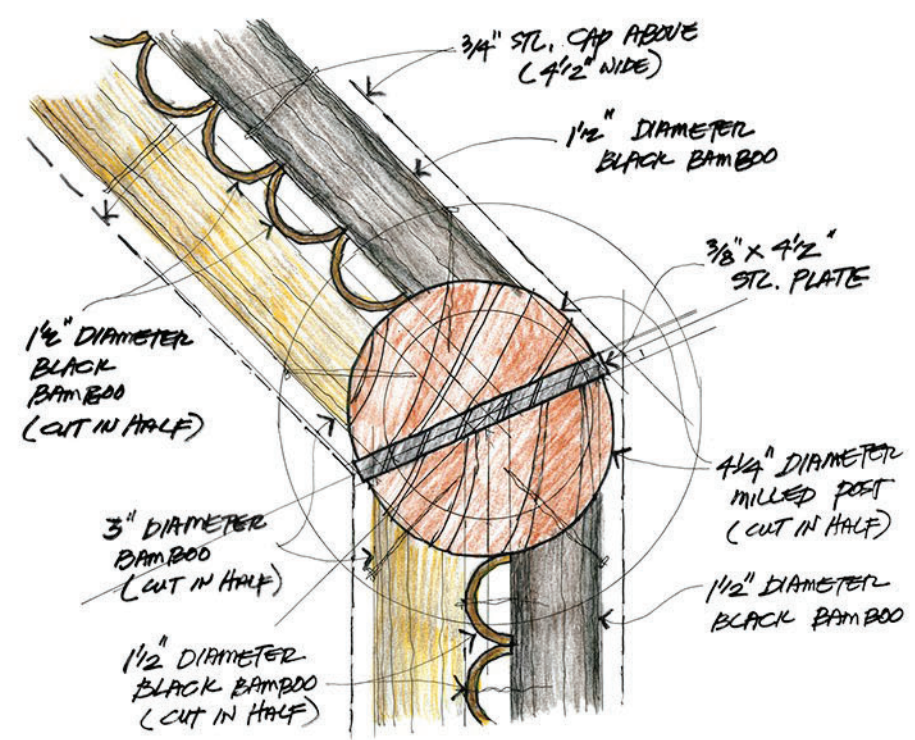
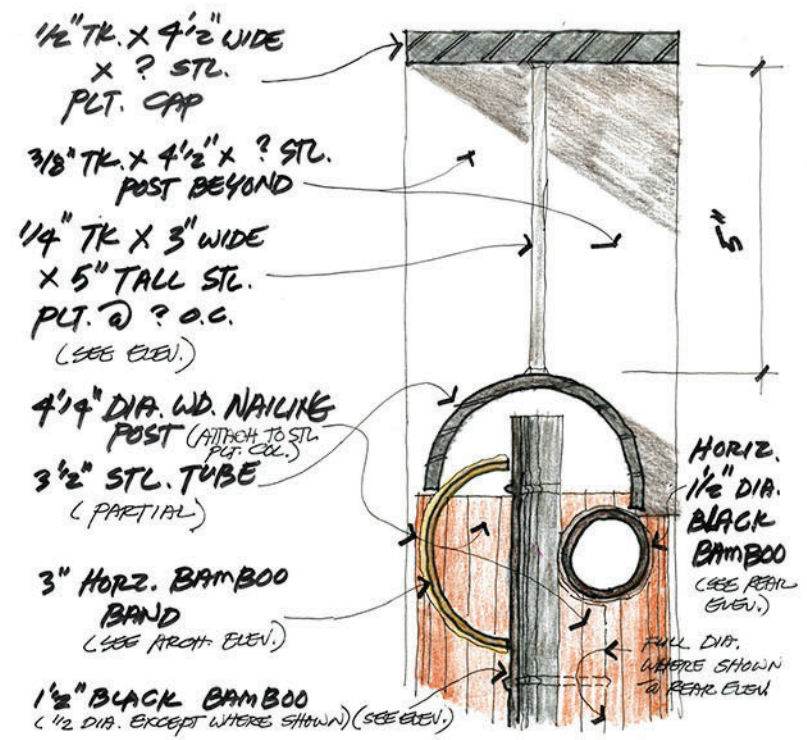

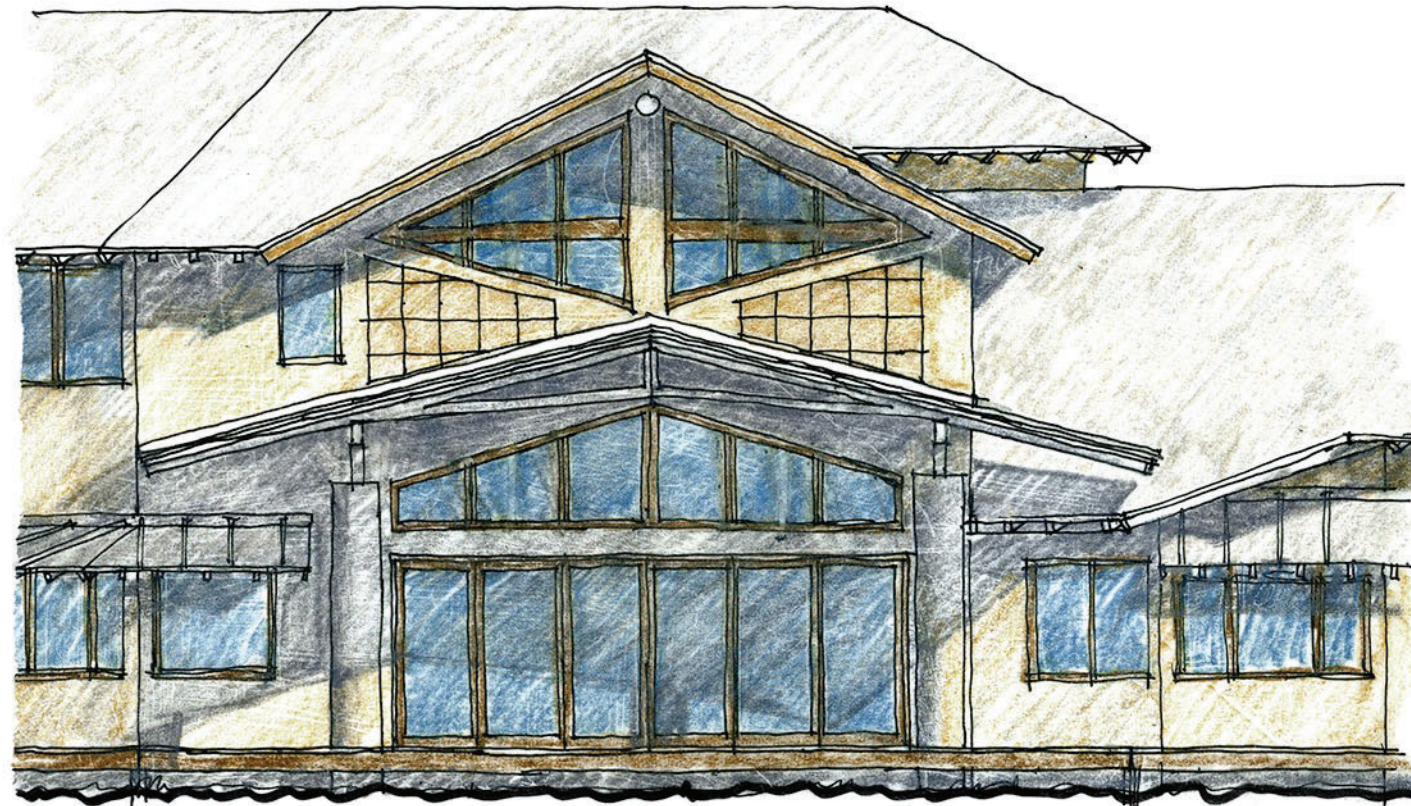
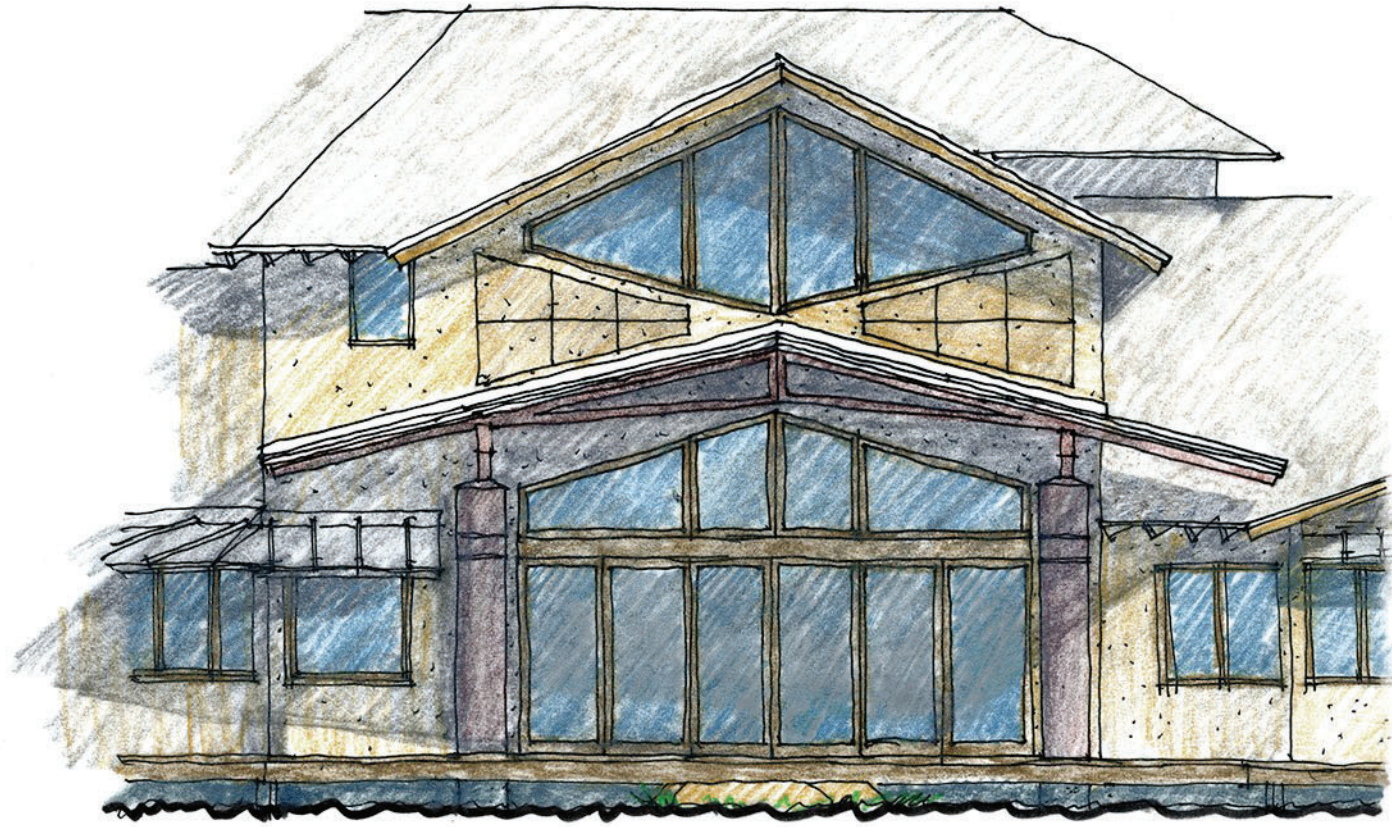

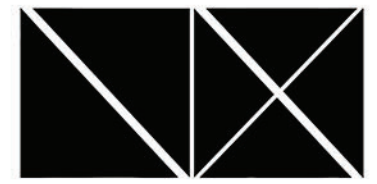
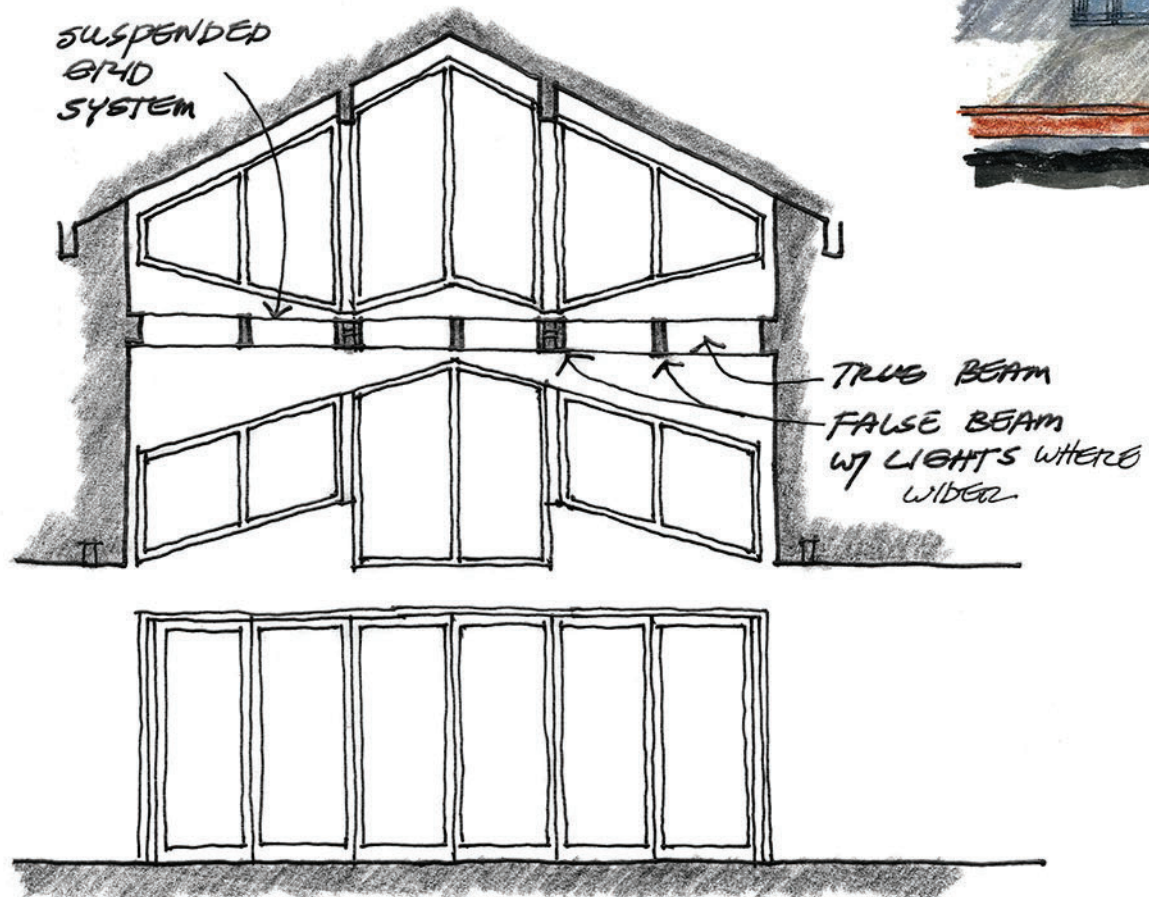
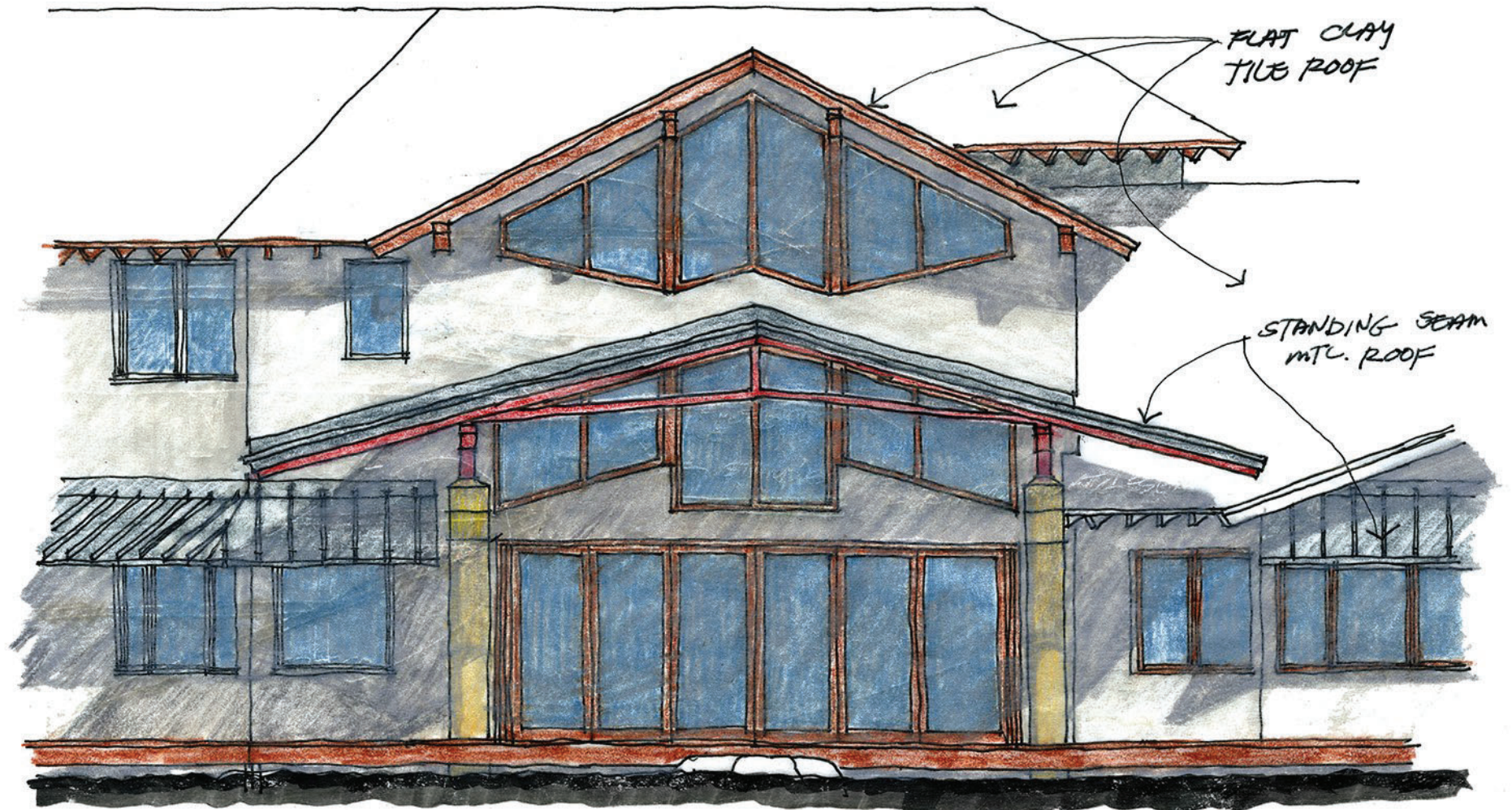

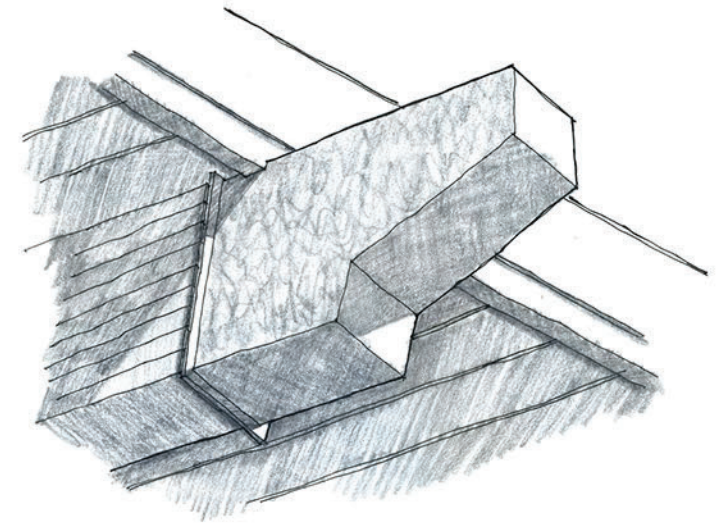
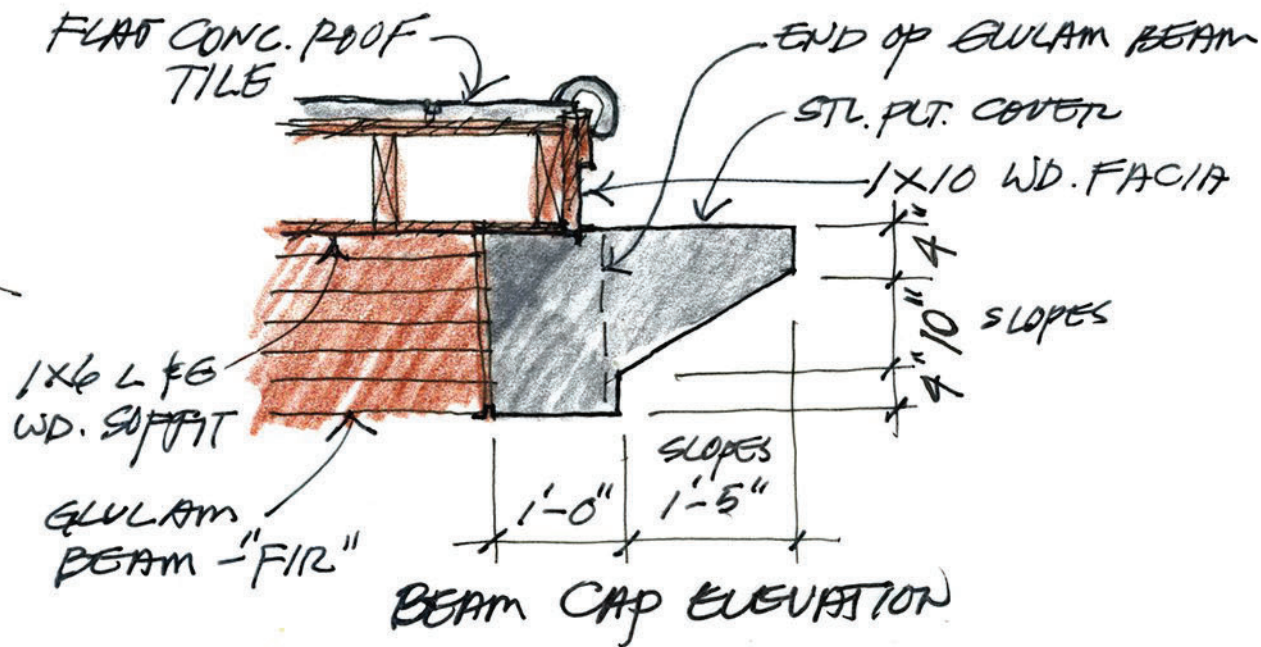
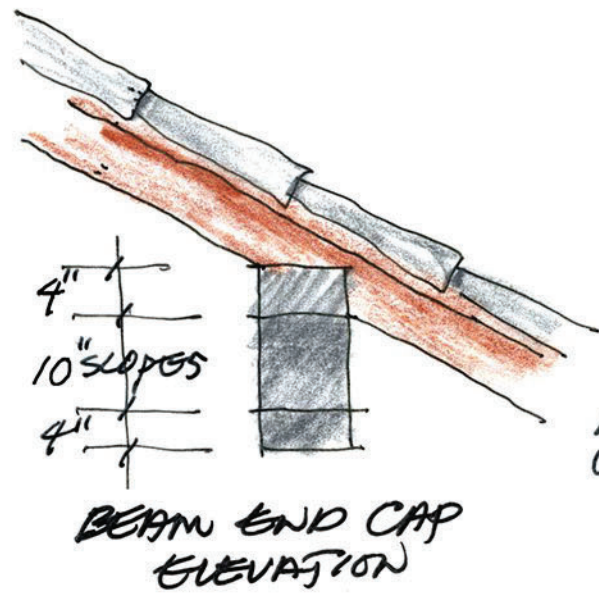
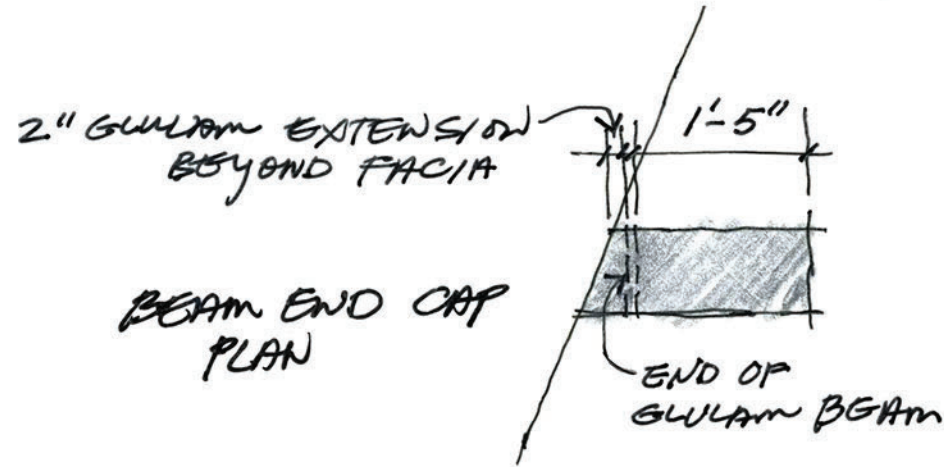
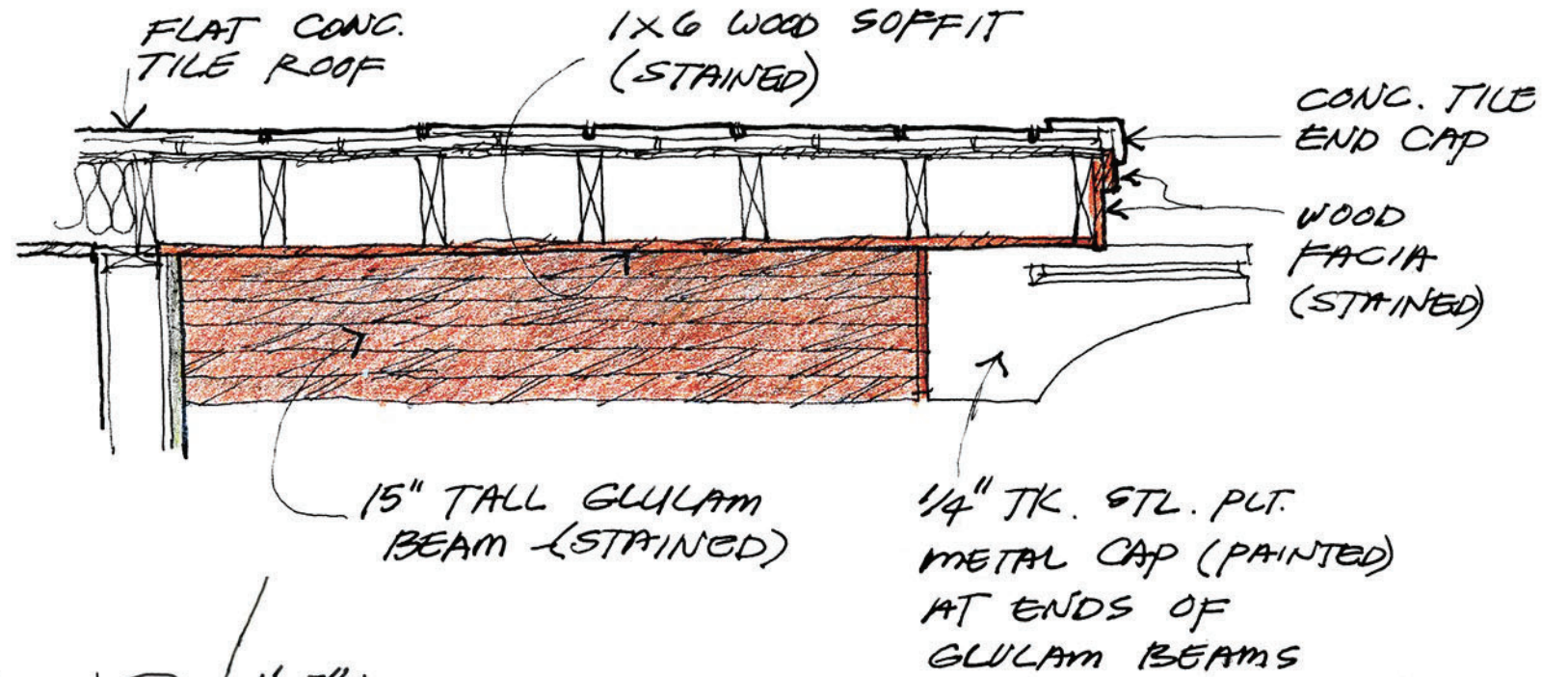
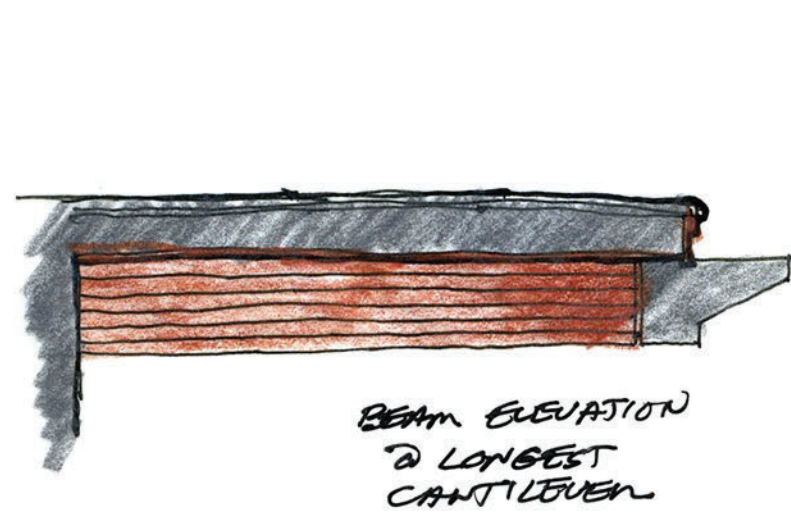

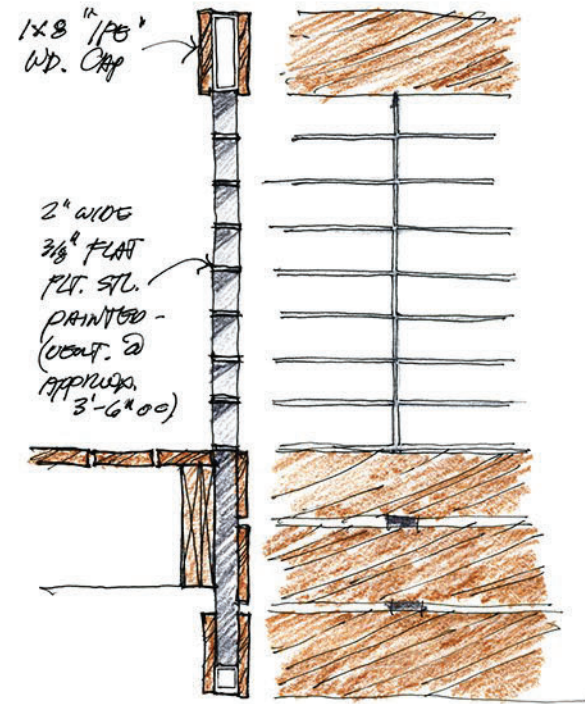

GUARDRAIL #1

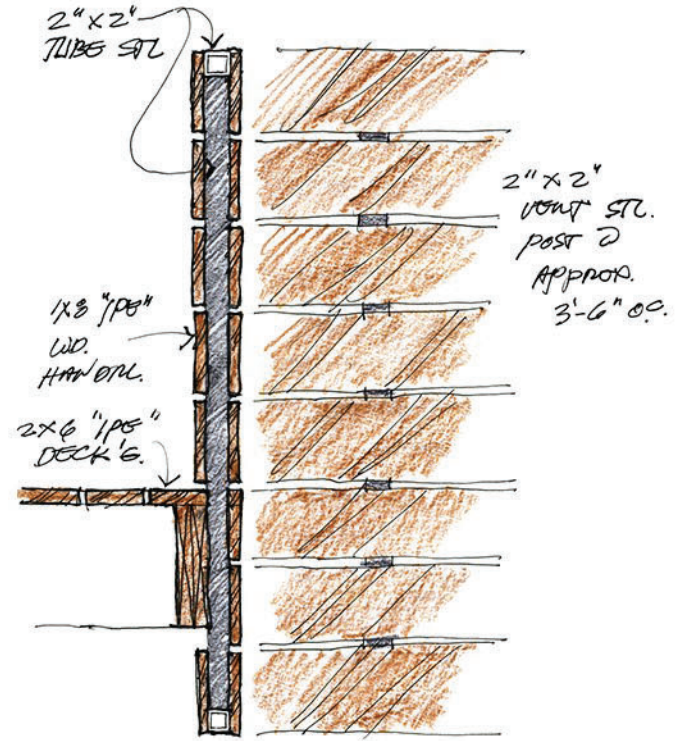
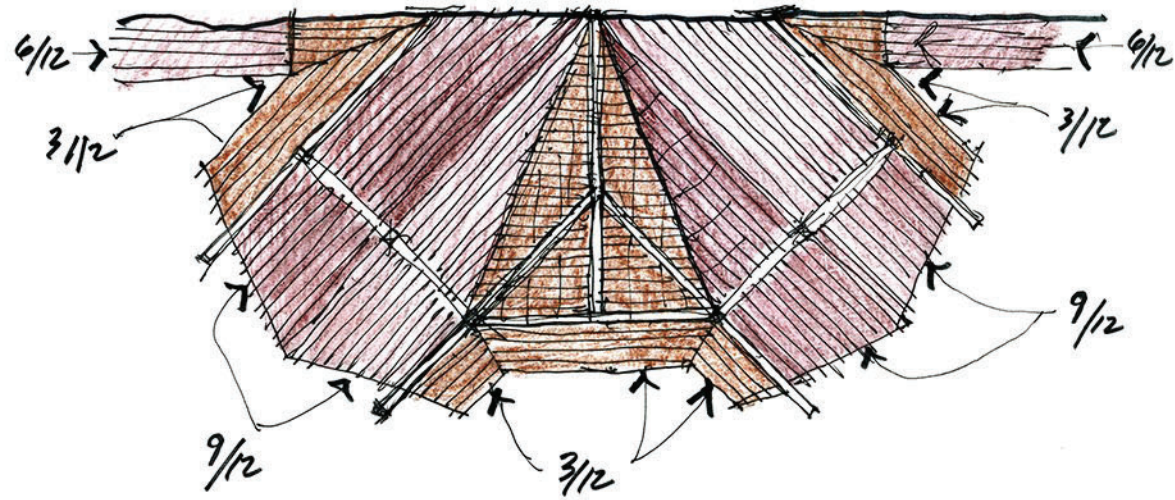

GUARDRAIL #2

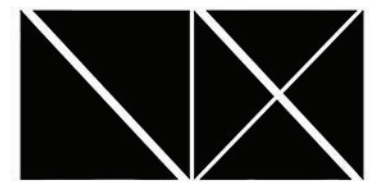
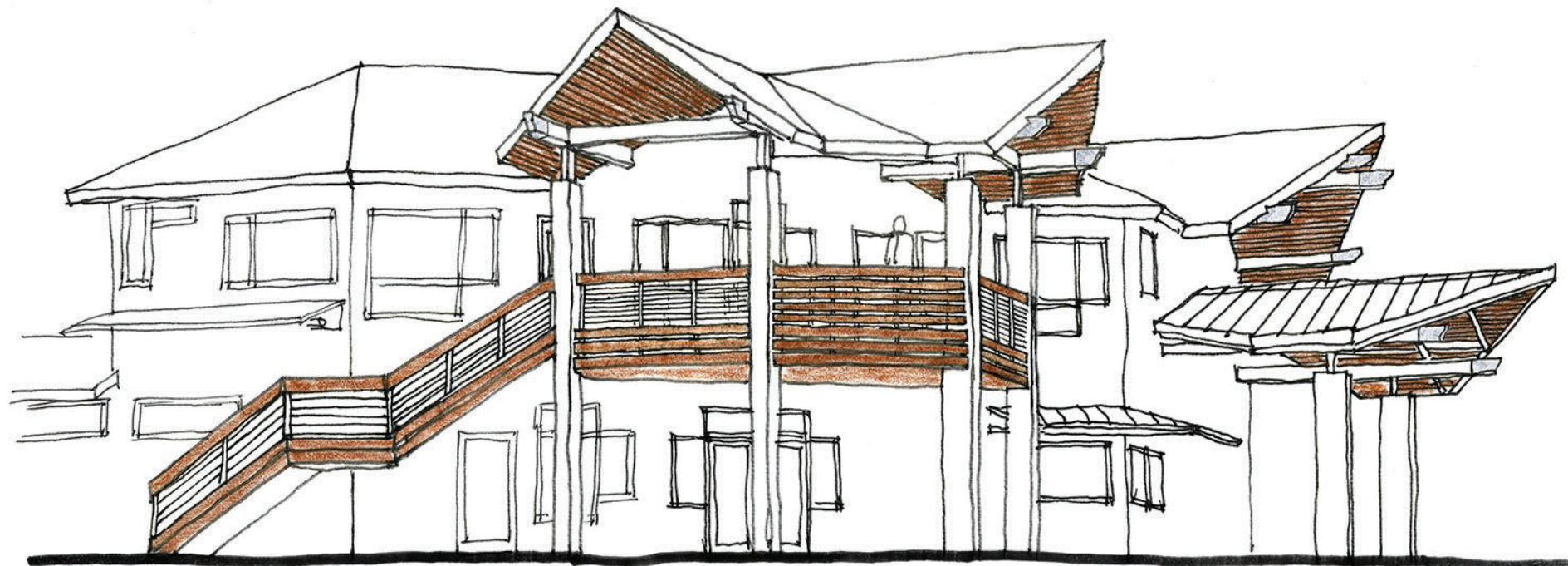

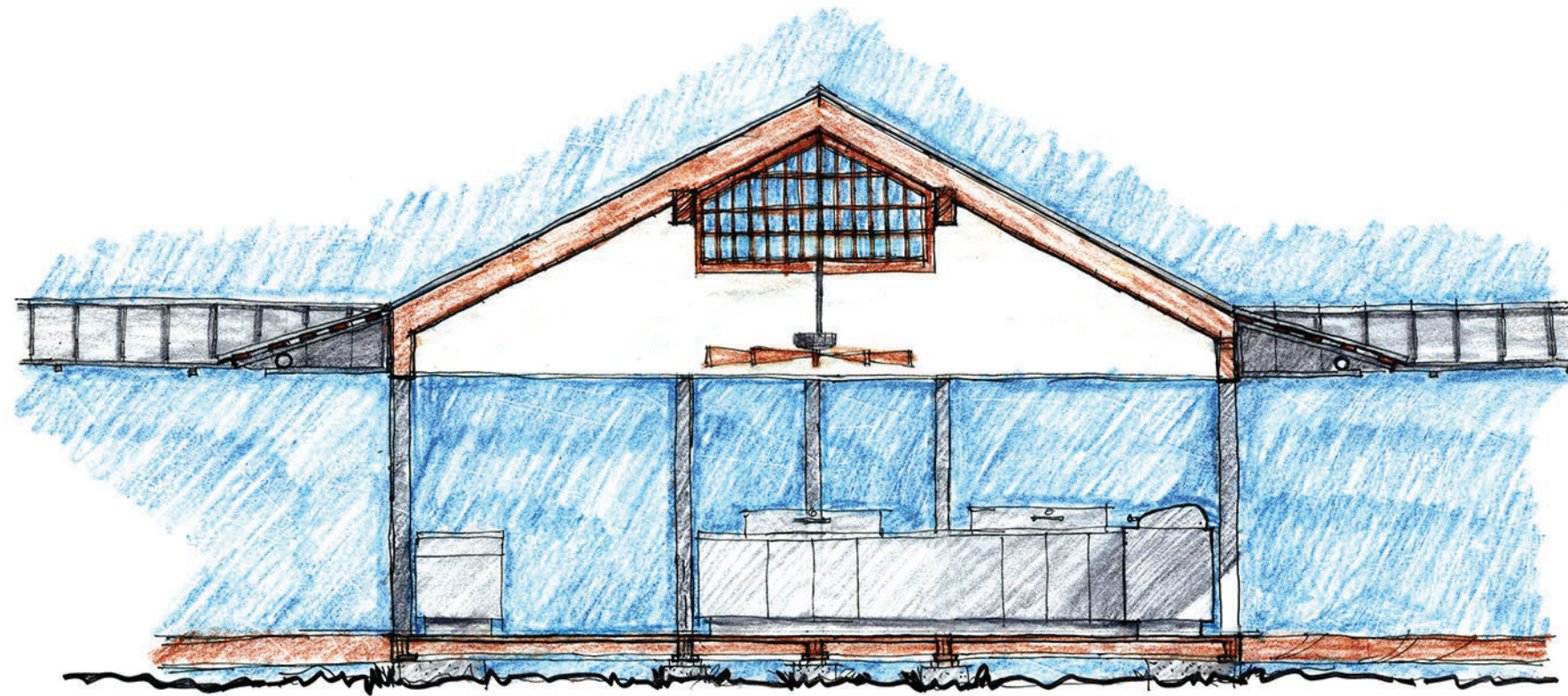

BUILDING SECT # B-B
@ CABANA

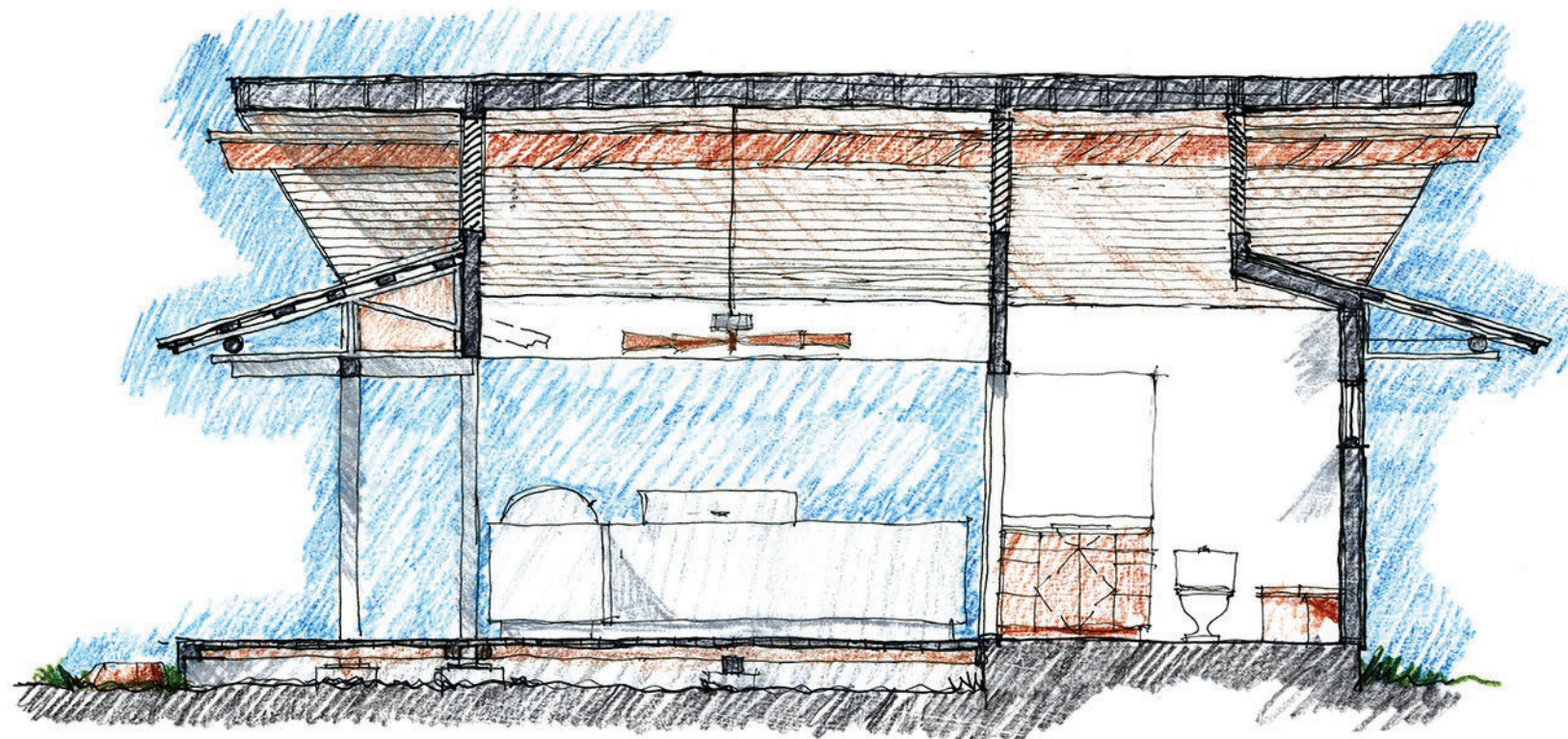

BUILDING SECT # A-A
@ CABANA

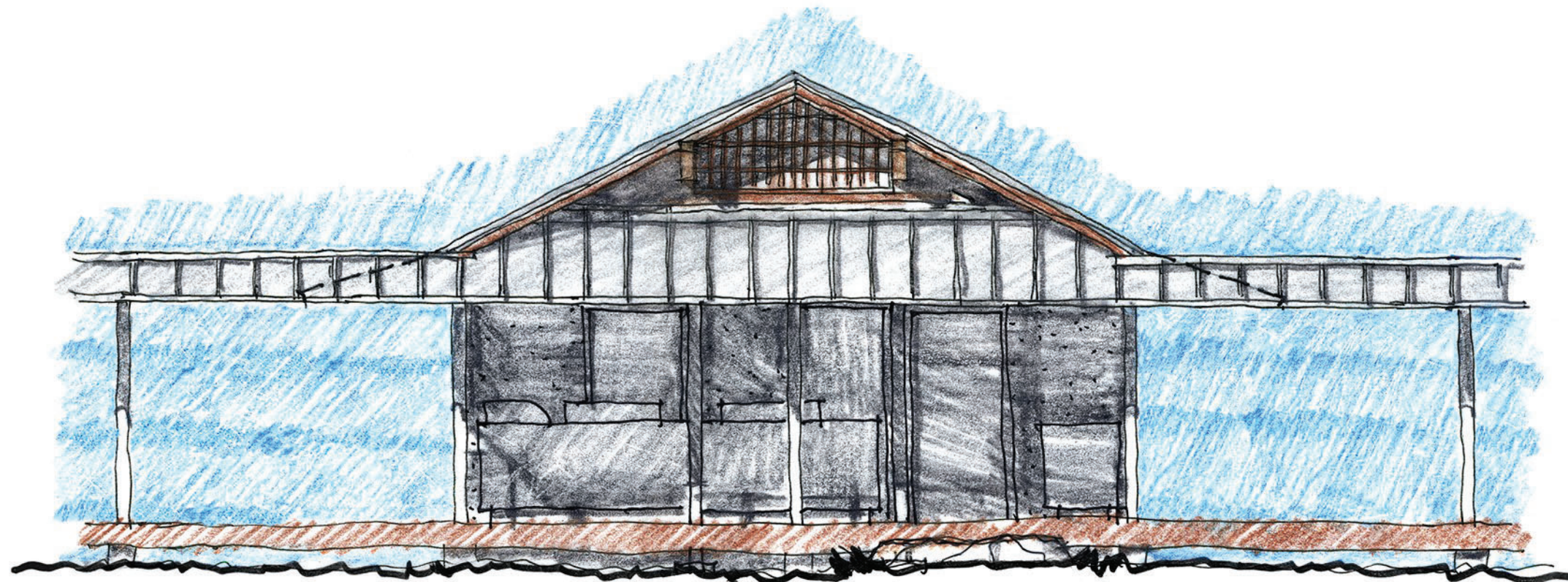

ELEVATION

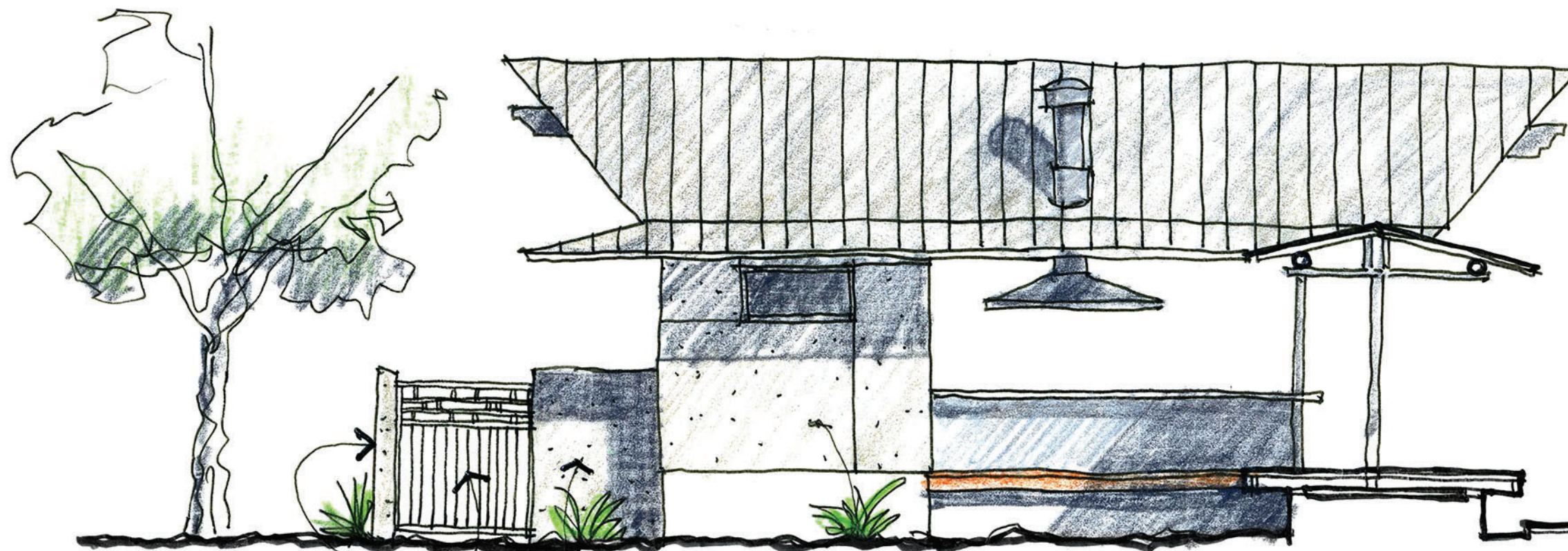

WROUGHT IRON FENCE
(MATCHES ENTRY COURT AND
UTILITY COURT FENCES)

POOL EQUIPMENT
SCREEN WALL

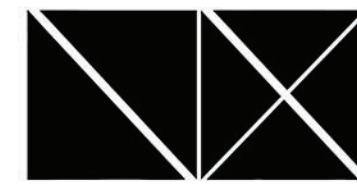

NIX GROUP
ARCHITECTS

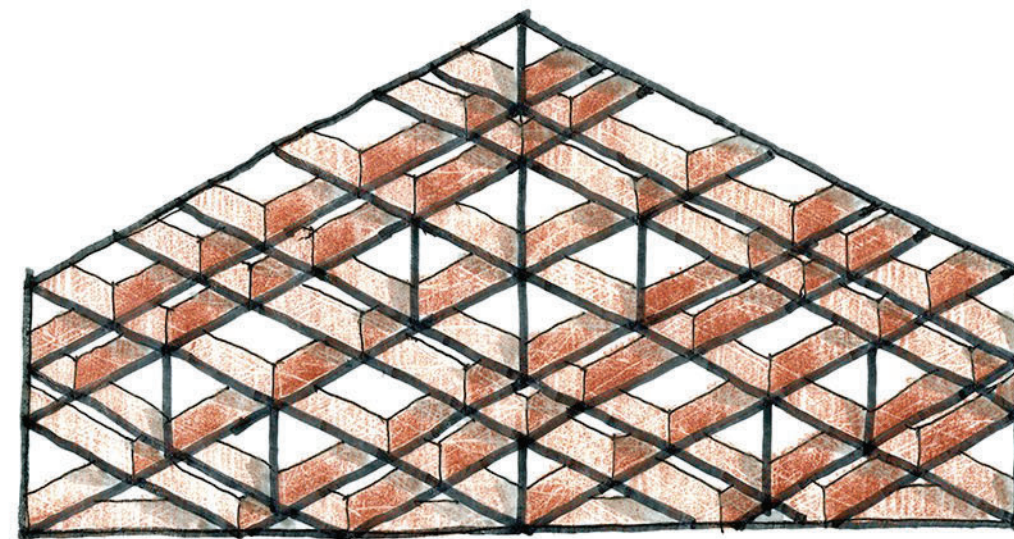
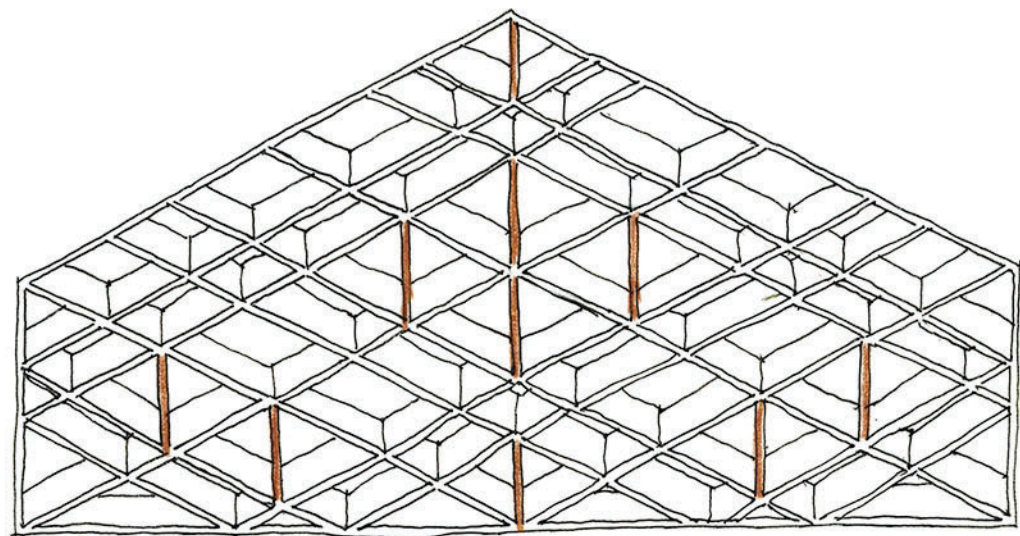
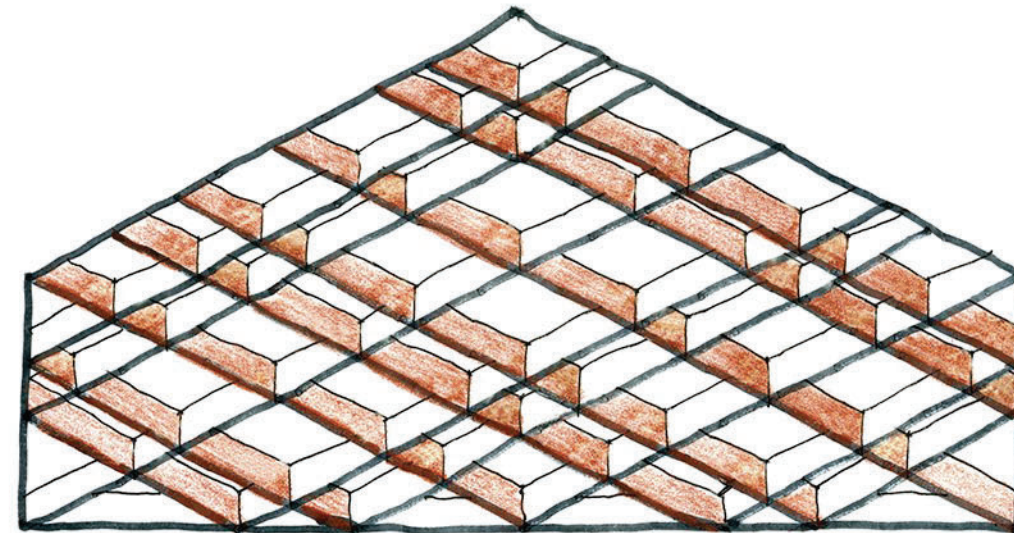
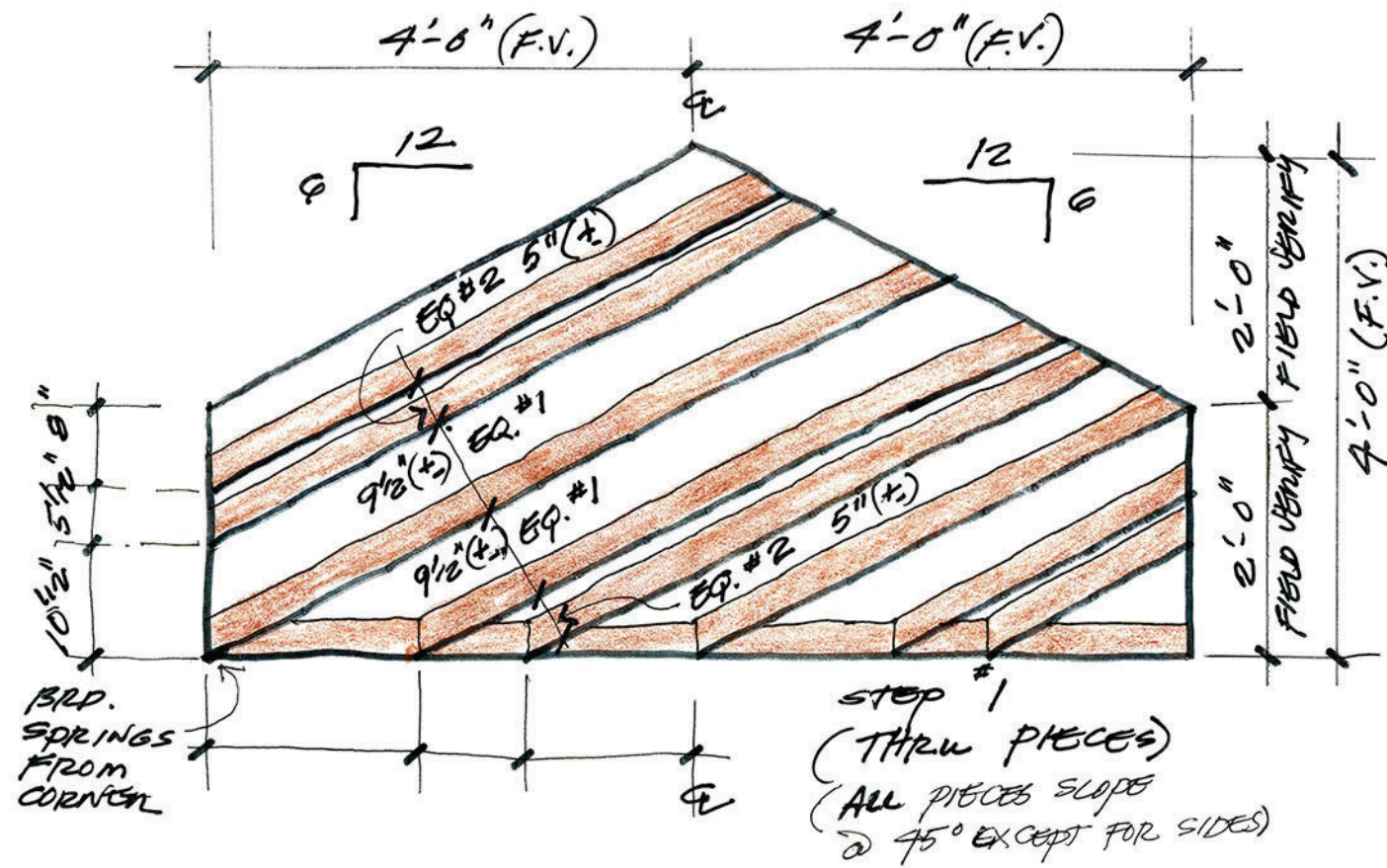

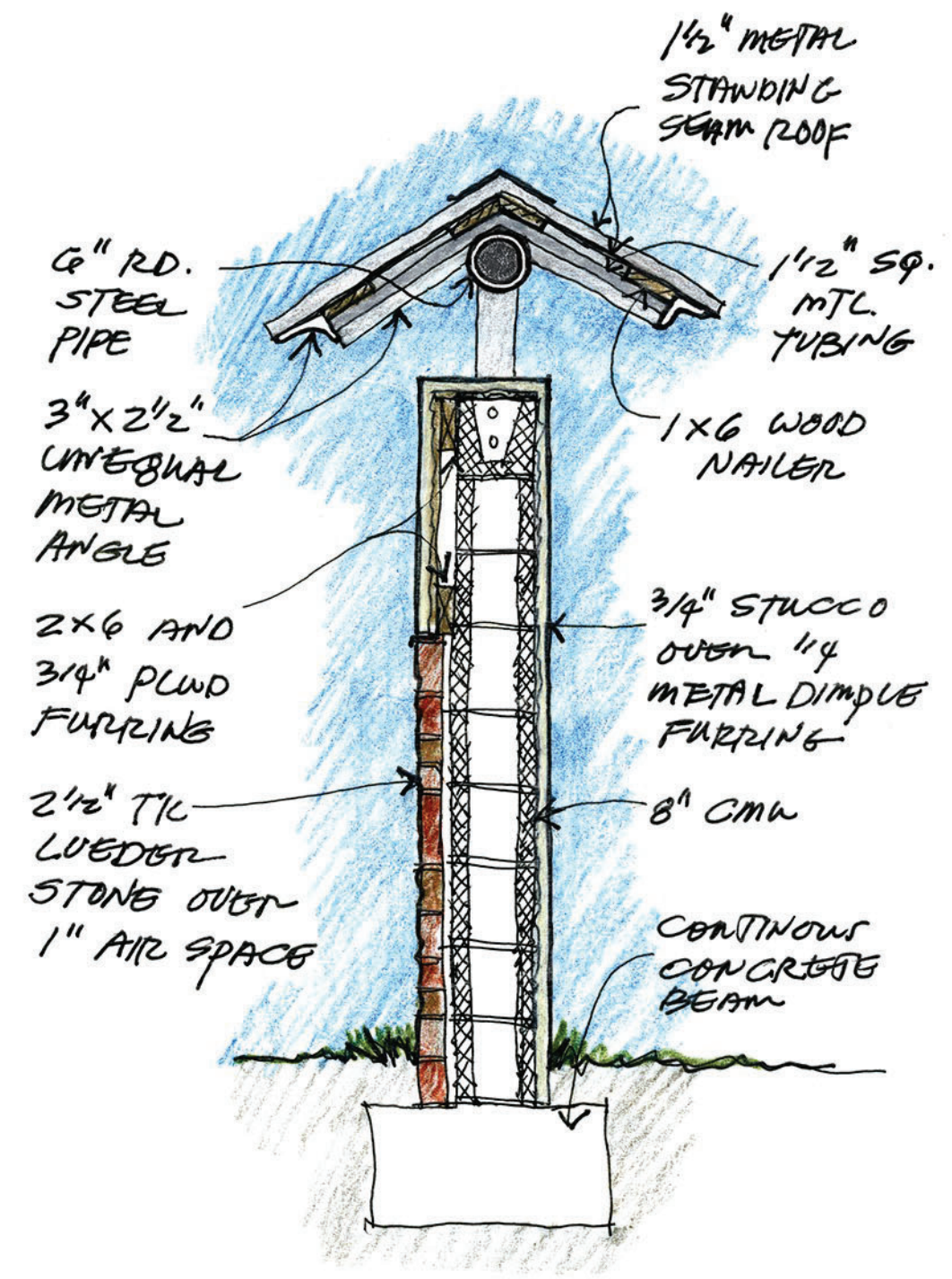
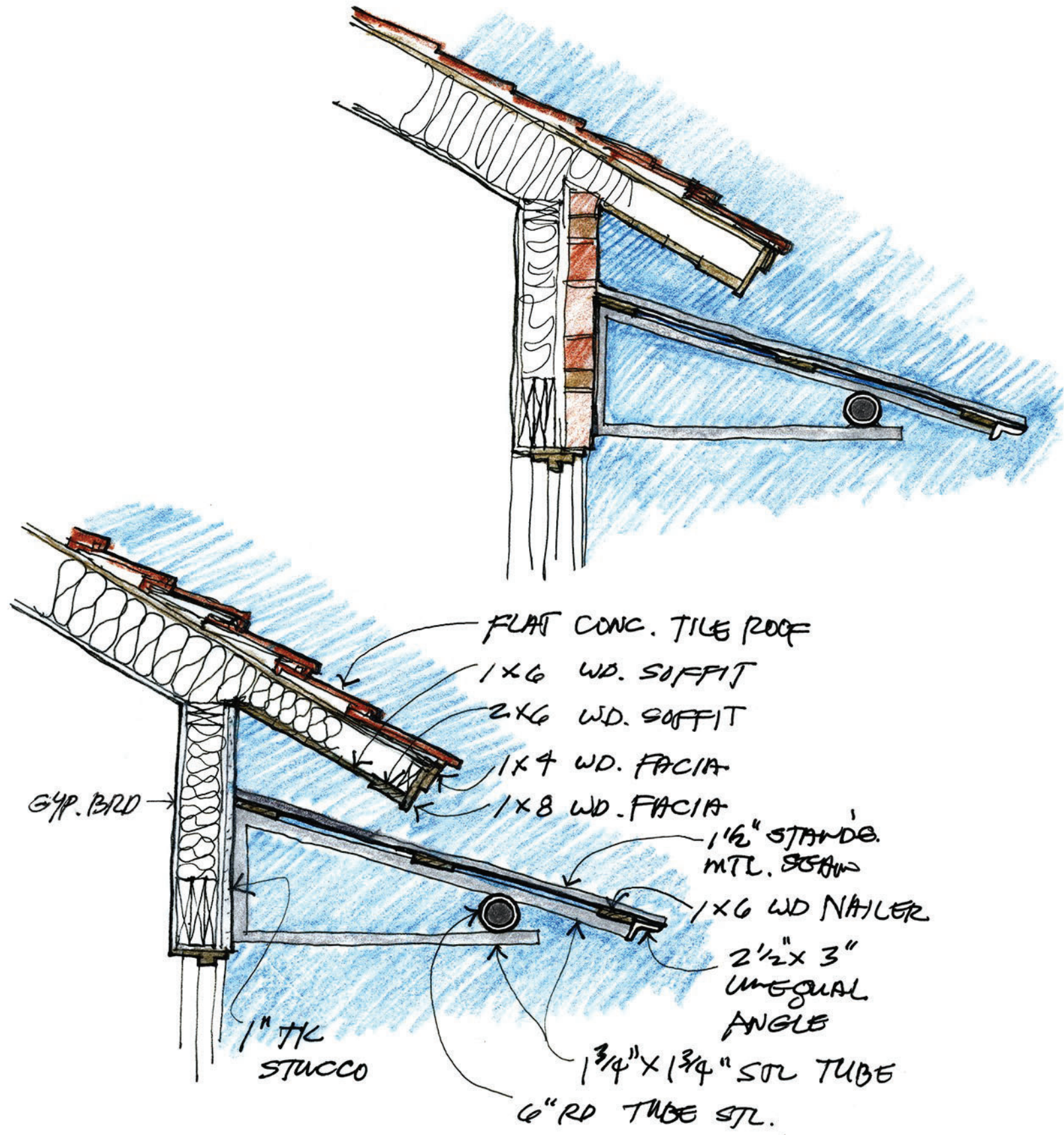

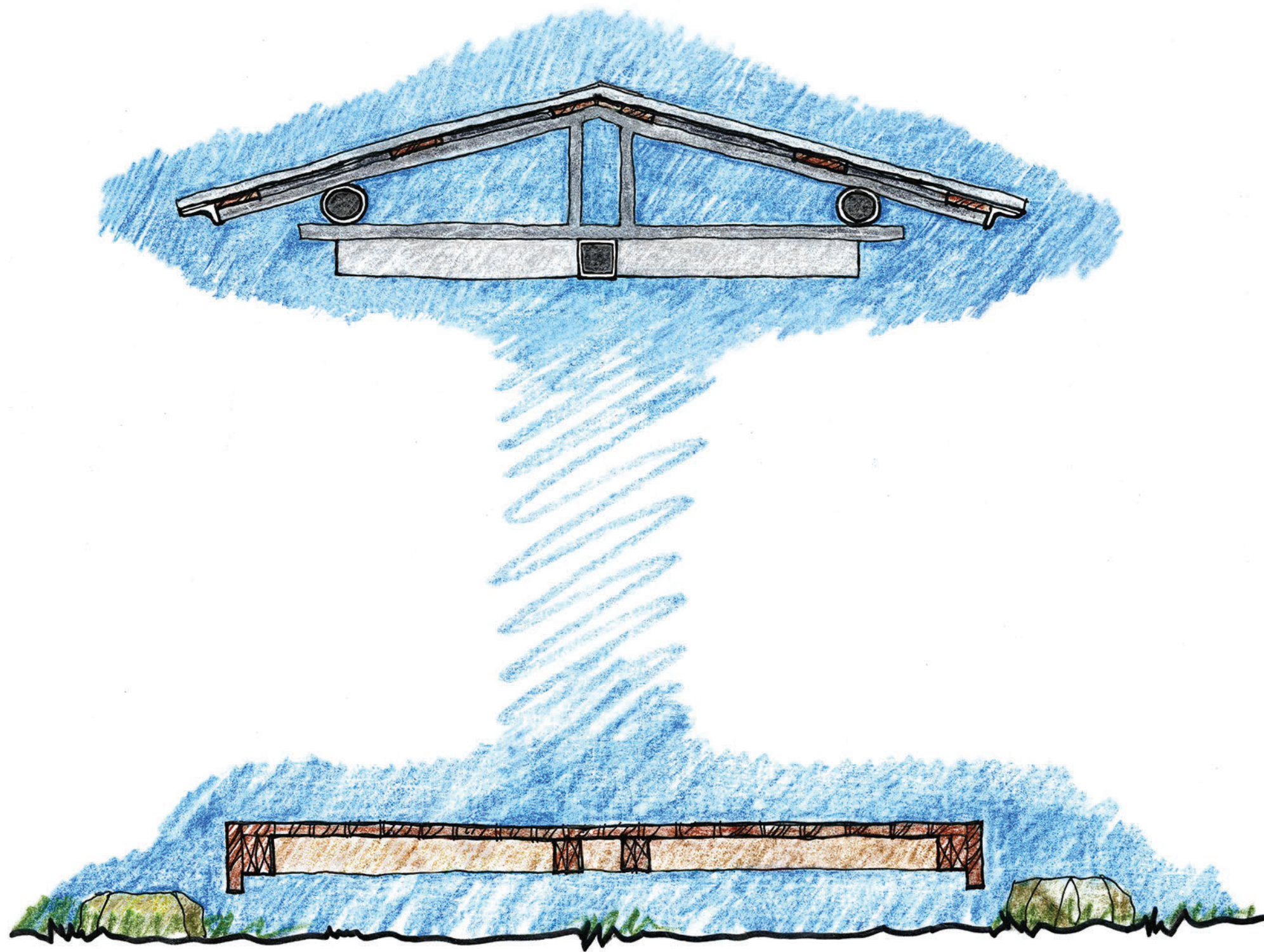

FRAME "D"
WALKWAY TO AND PAST CABANA

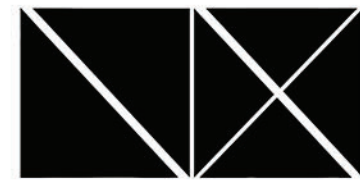

NIX GROUP
ARCHITECTS

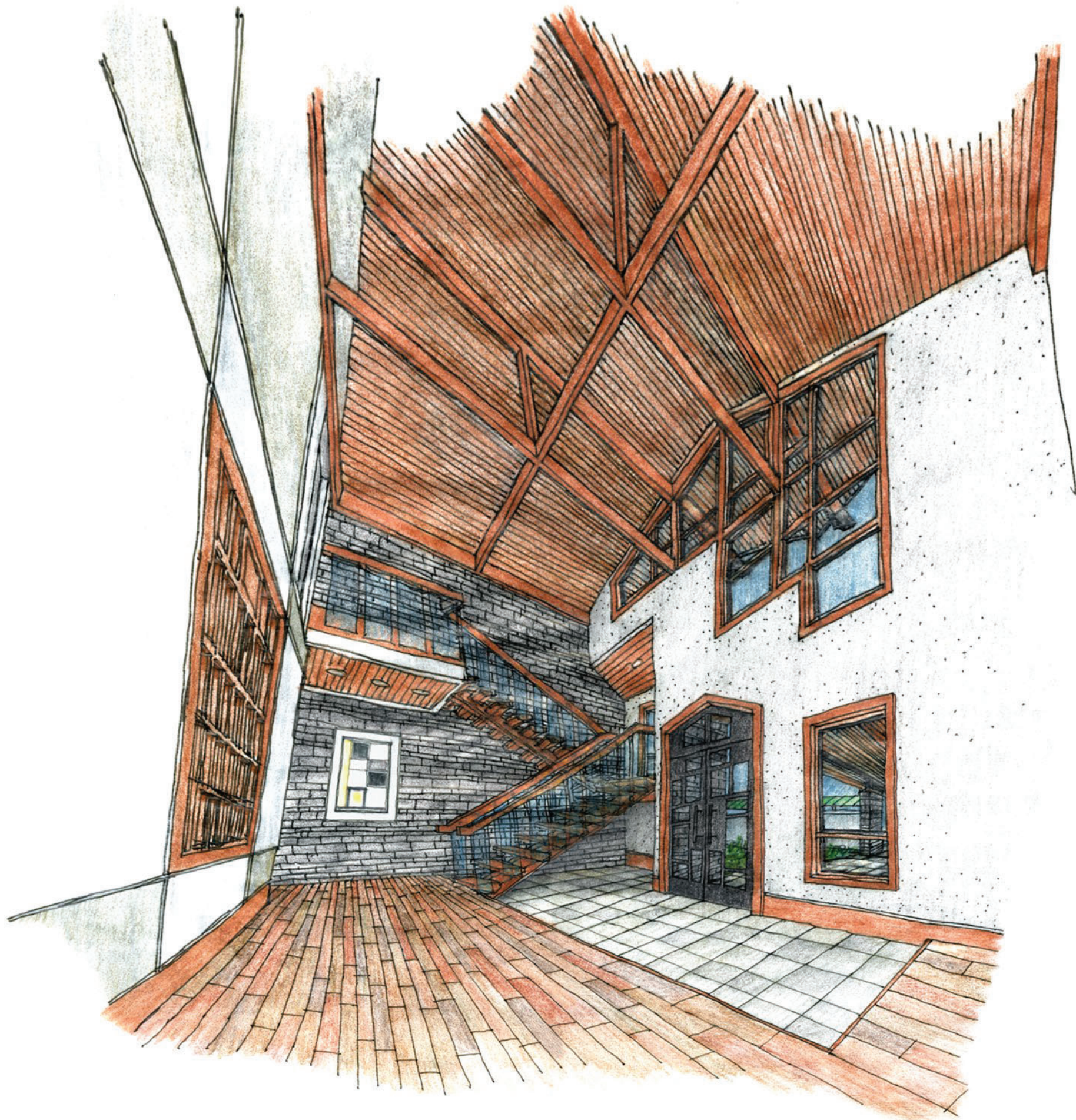

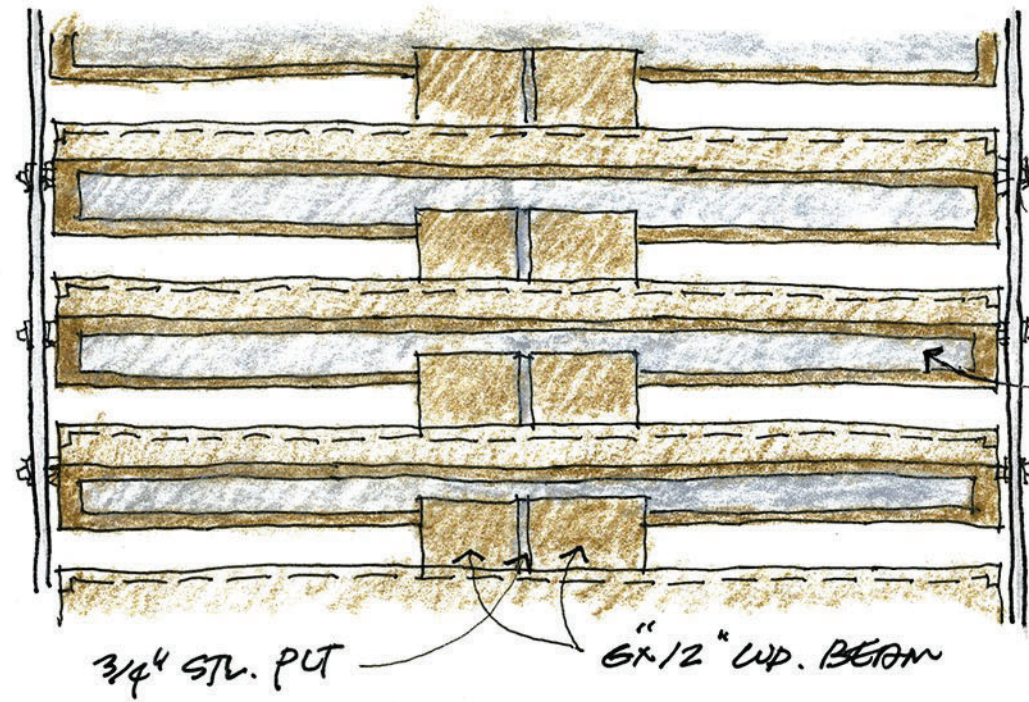

STAND-OFF
GLASS SUPPORT
BOLT

1/2" RECESSED
STL. THREADED
SUPPORT PLATE

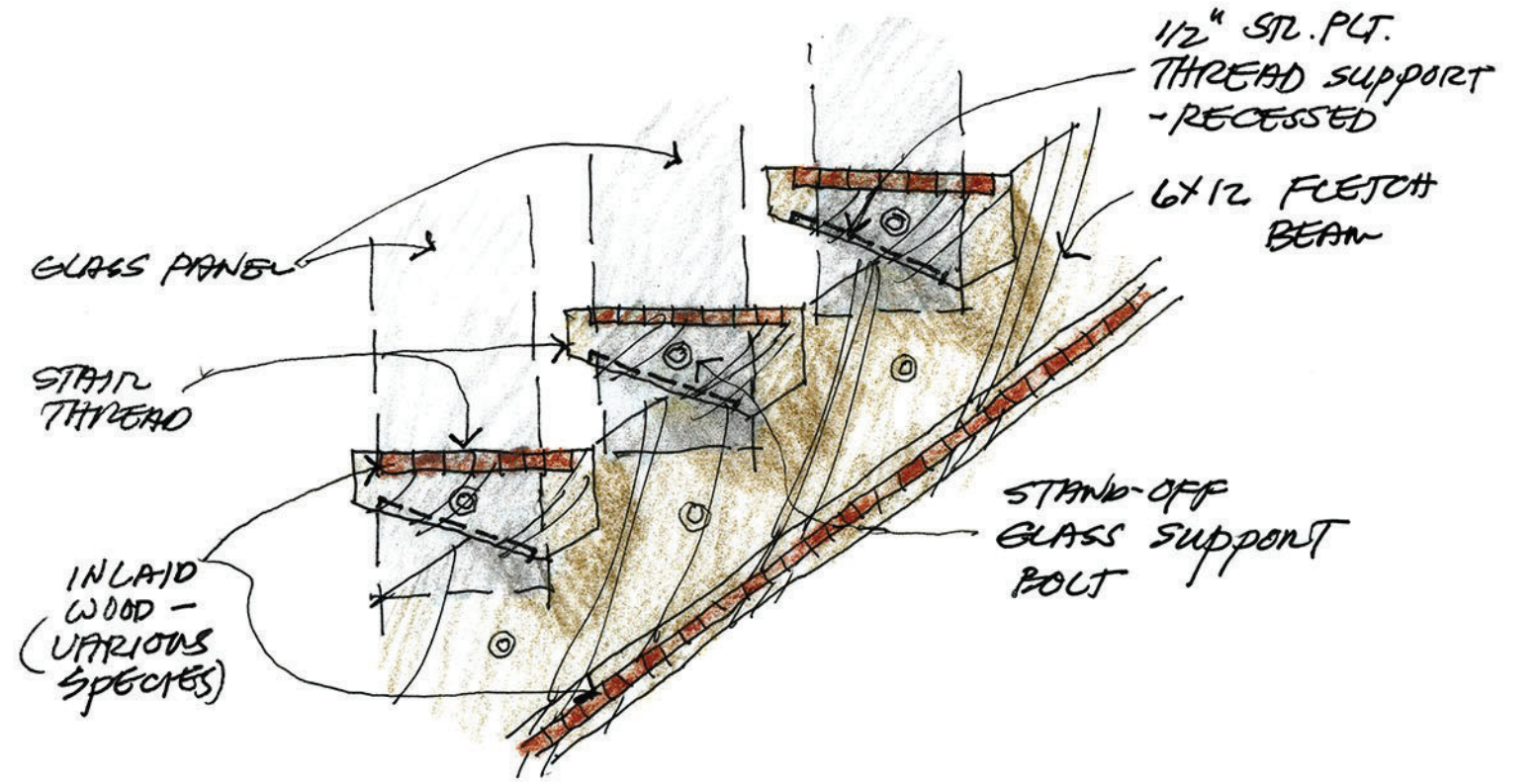
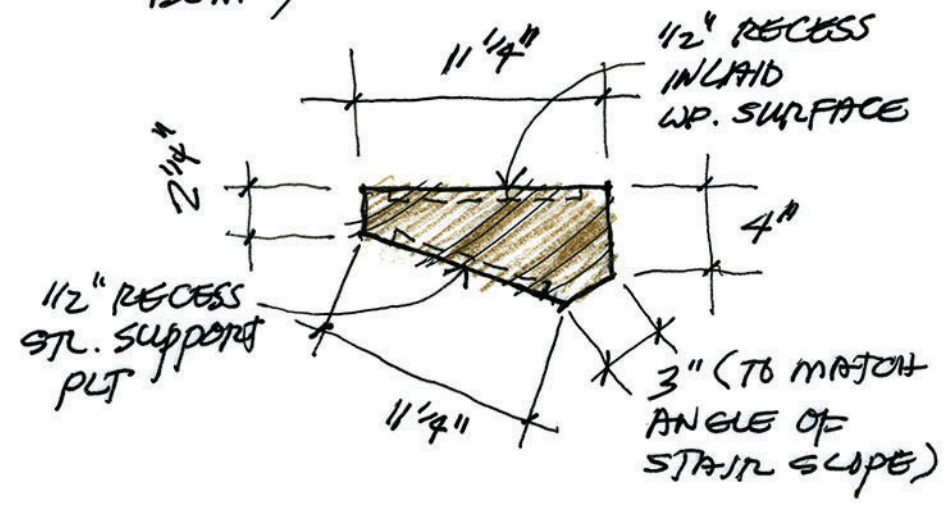
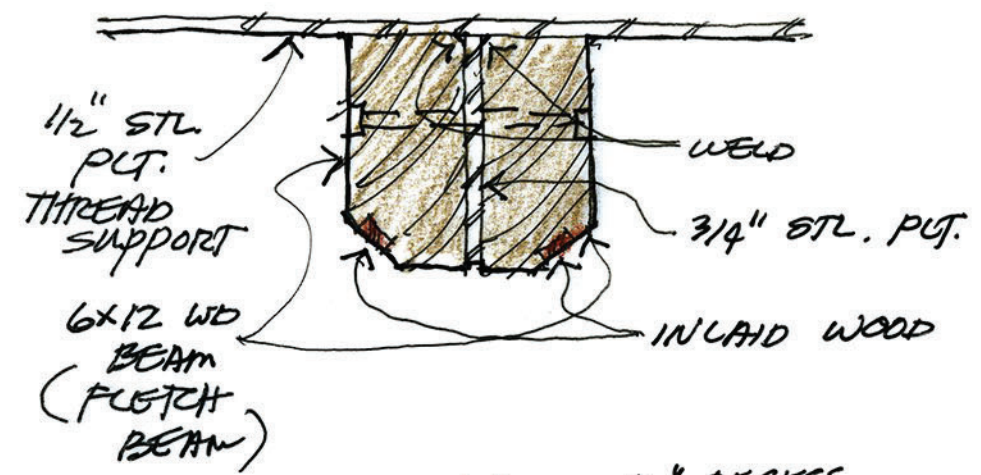
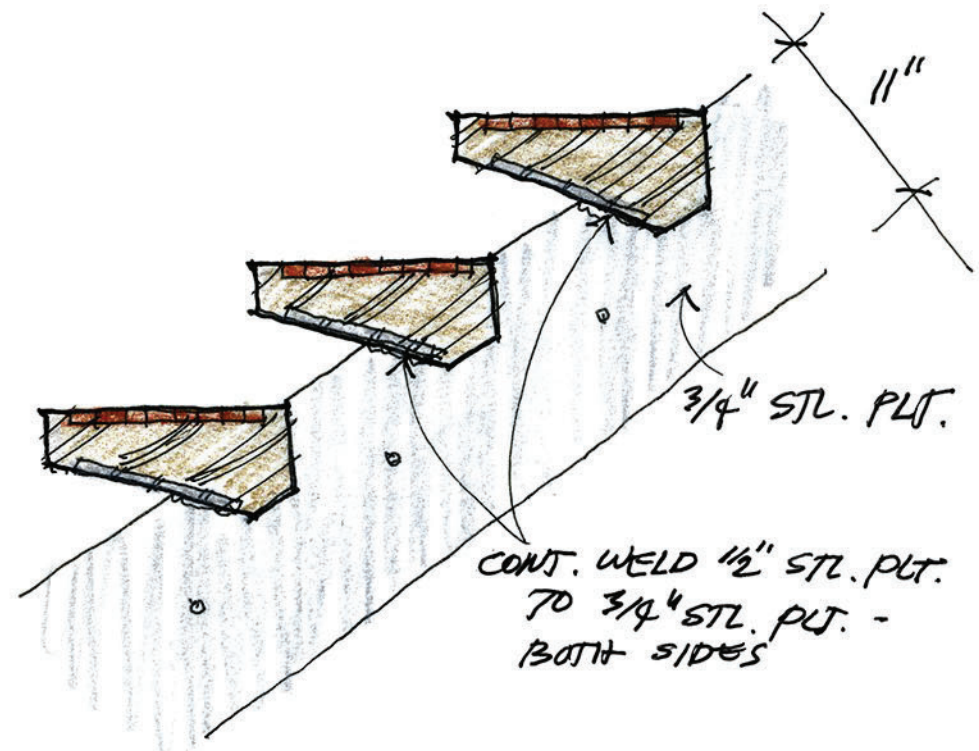

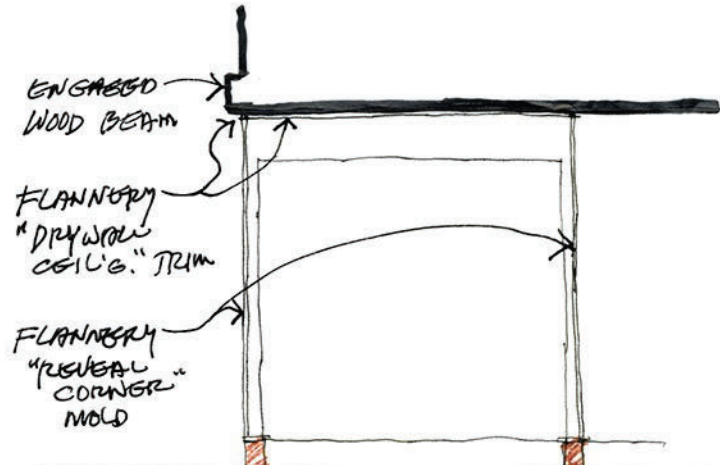
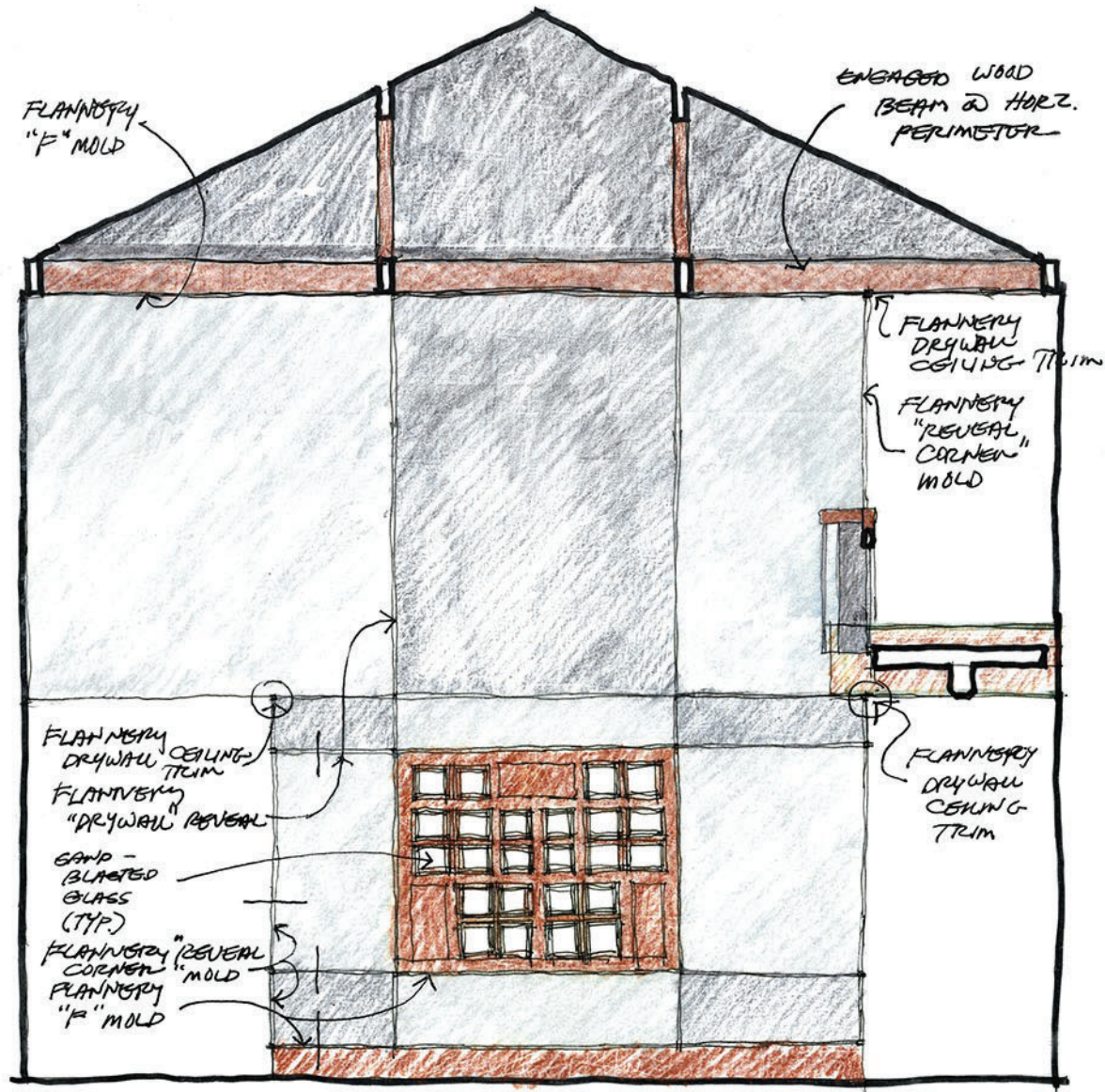

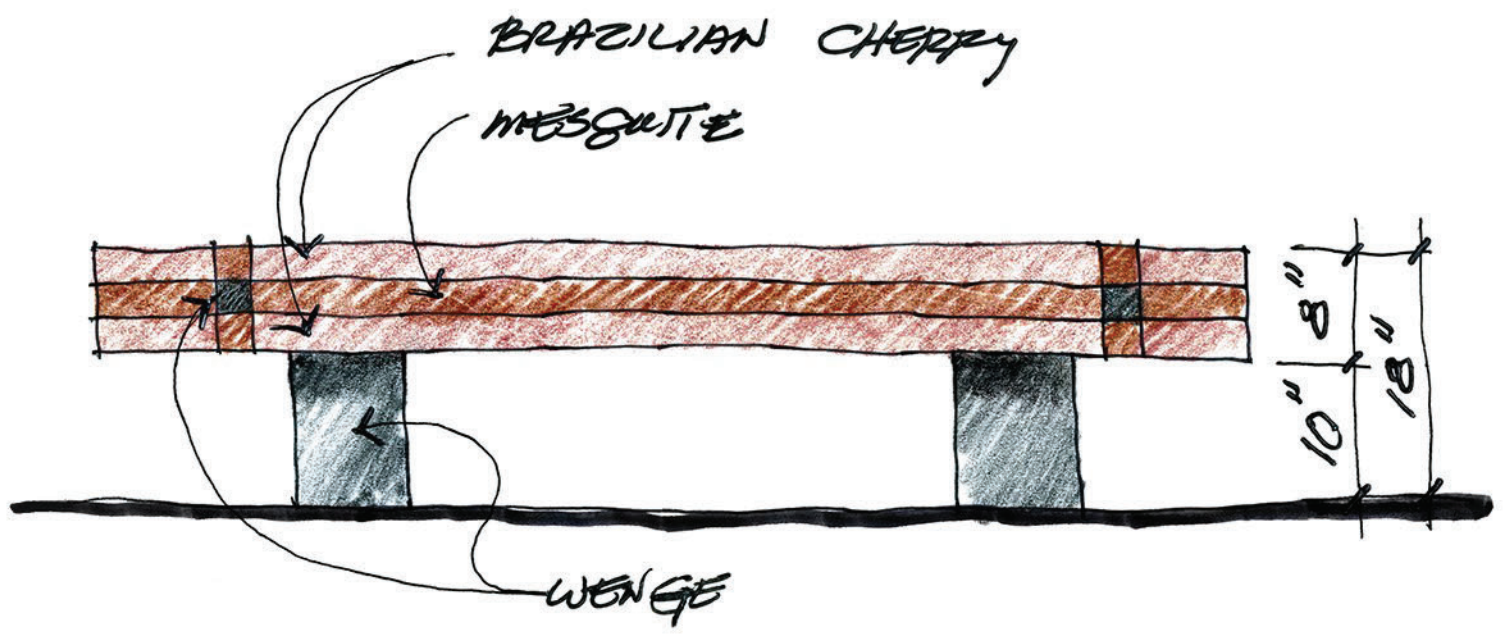
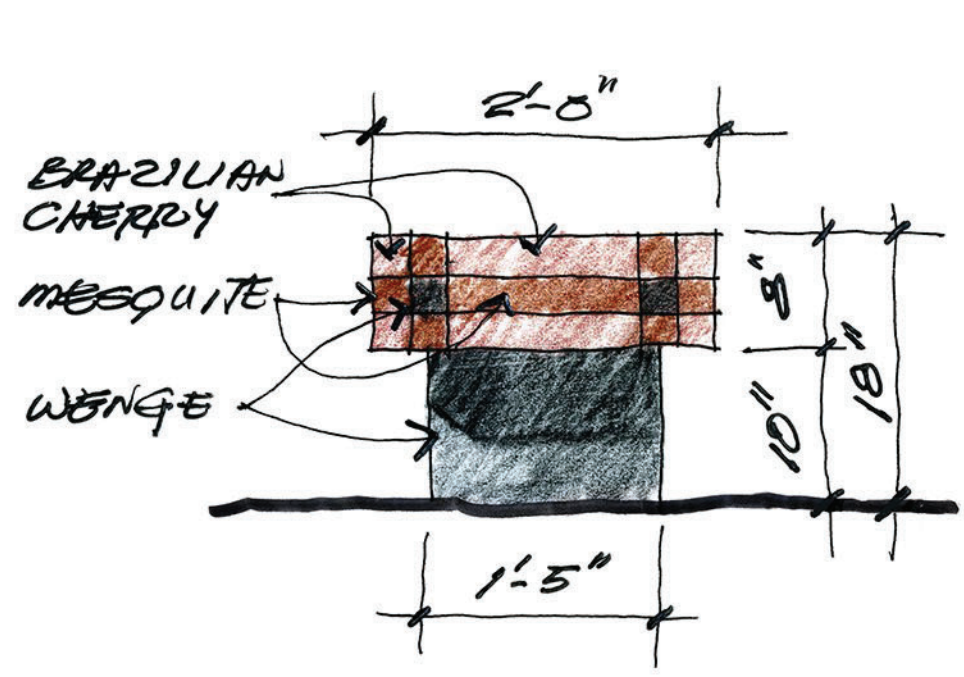
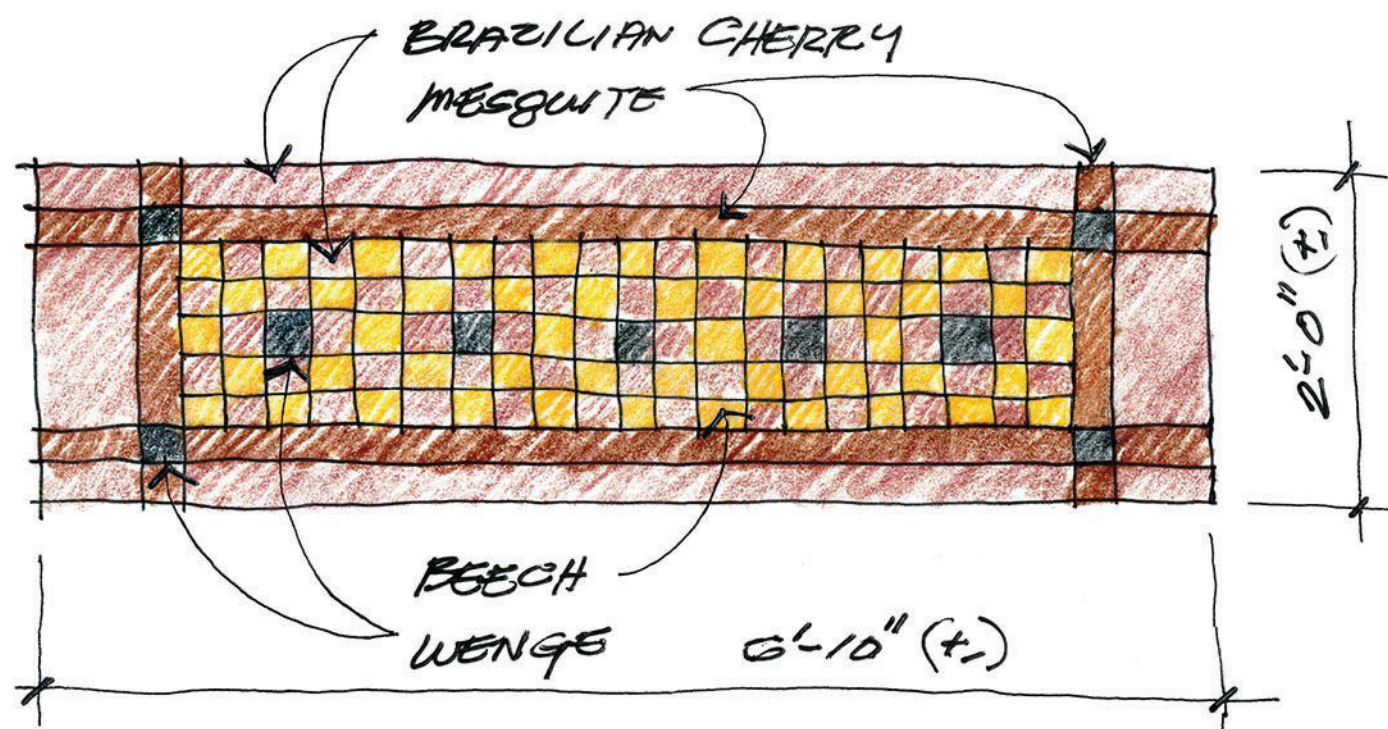

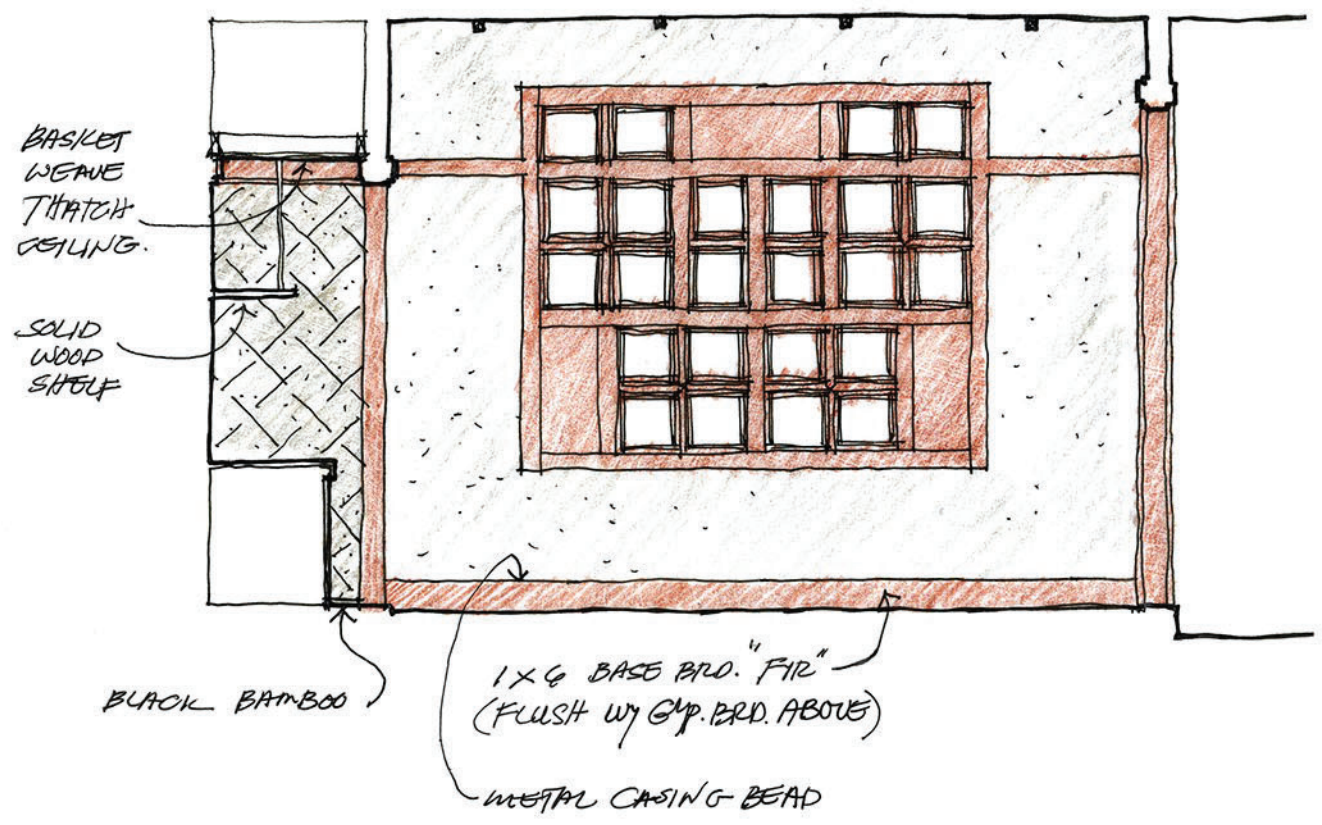
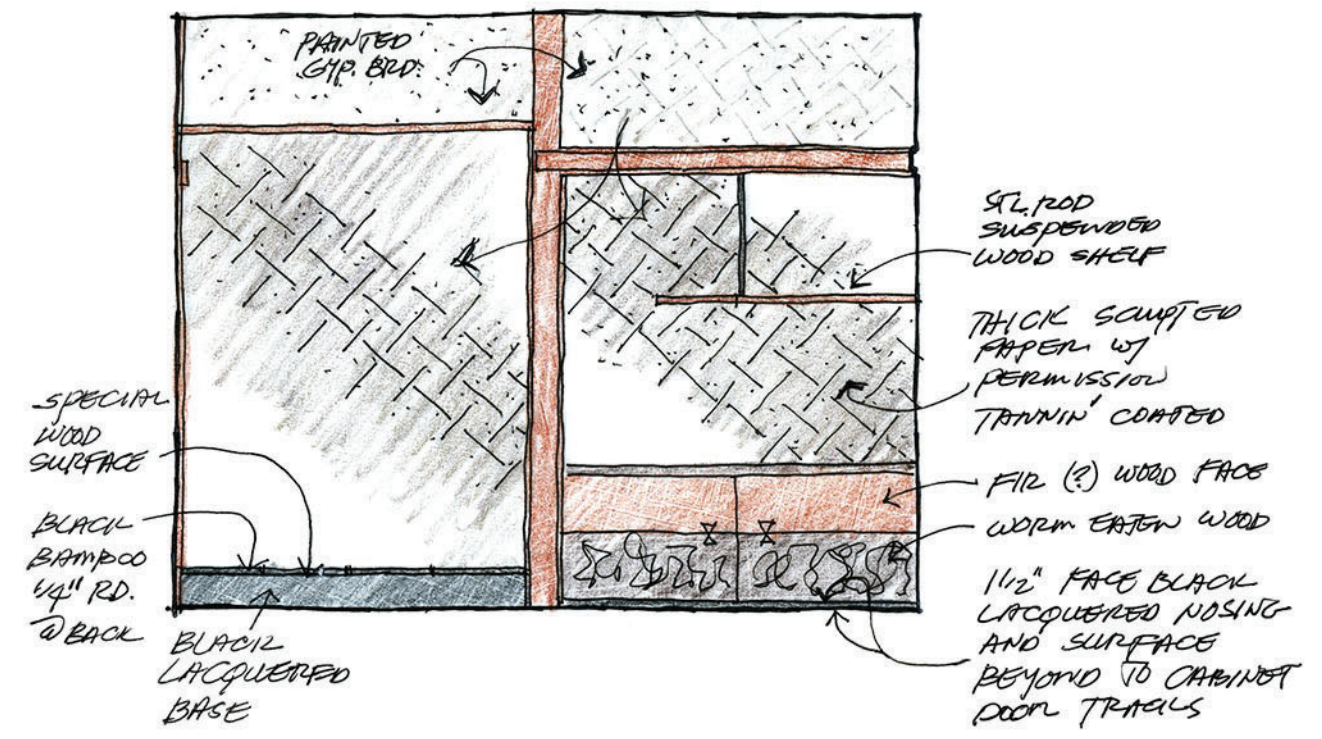
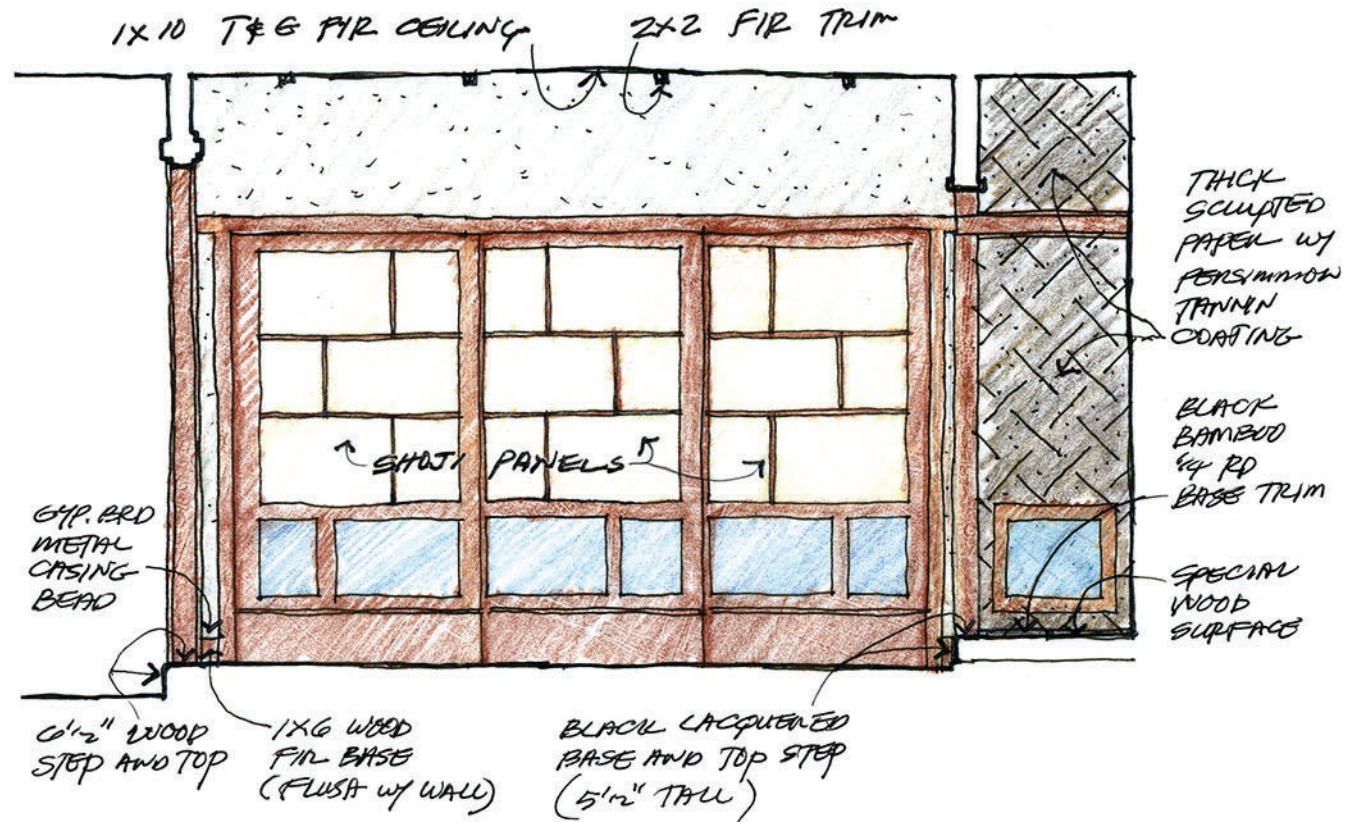

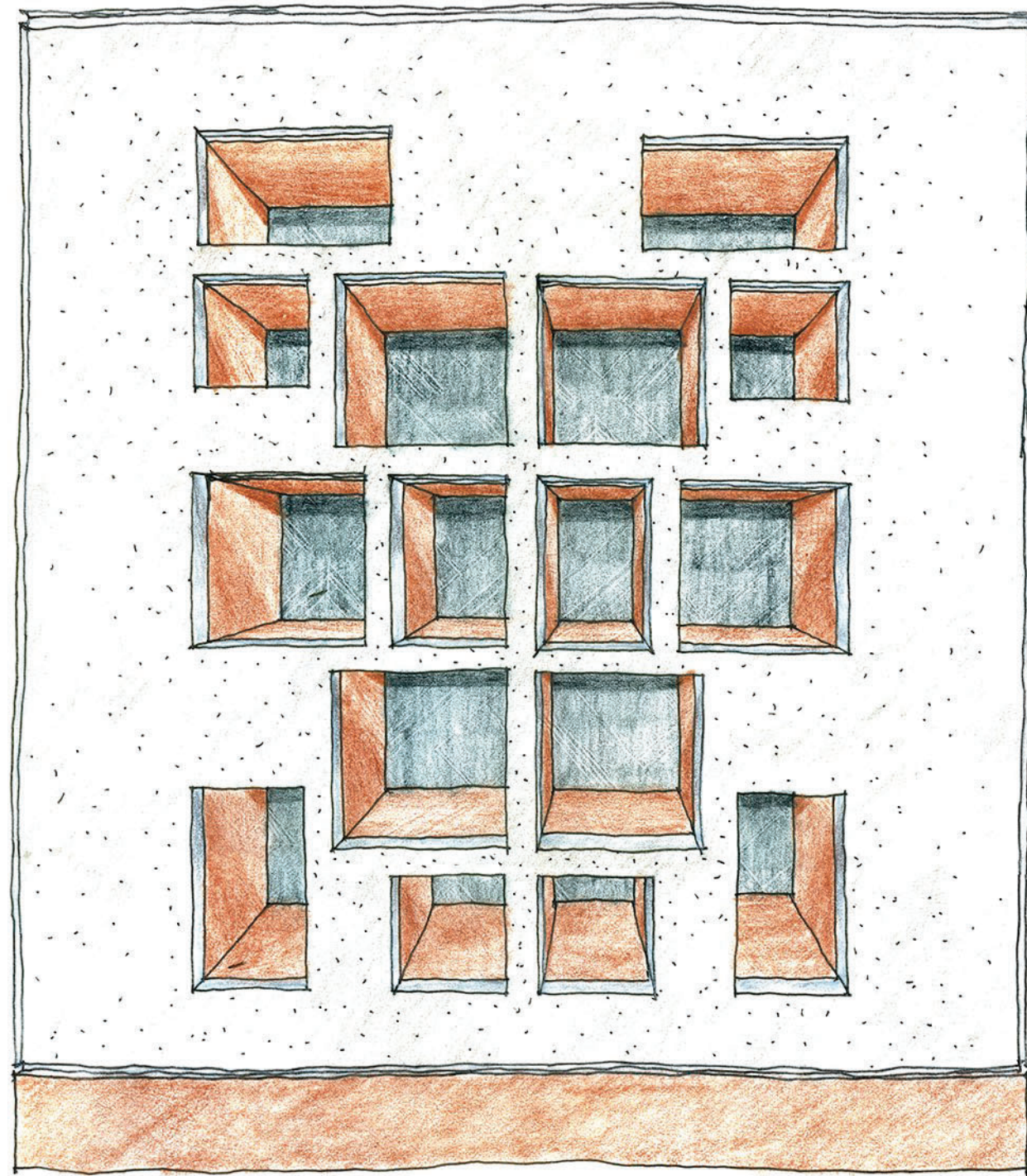

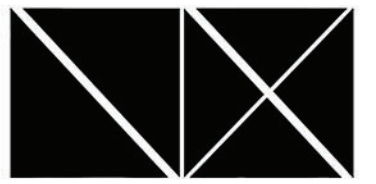

NIX GROUP
ARCHITECTS

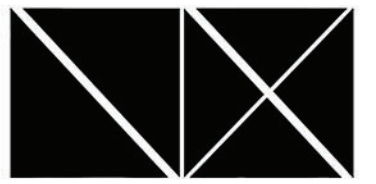
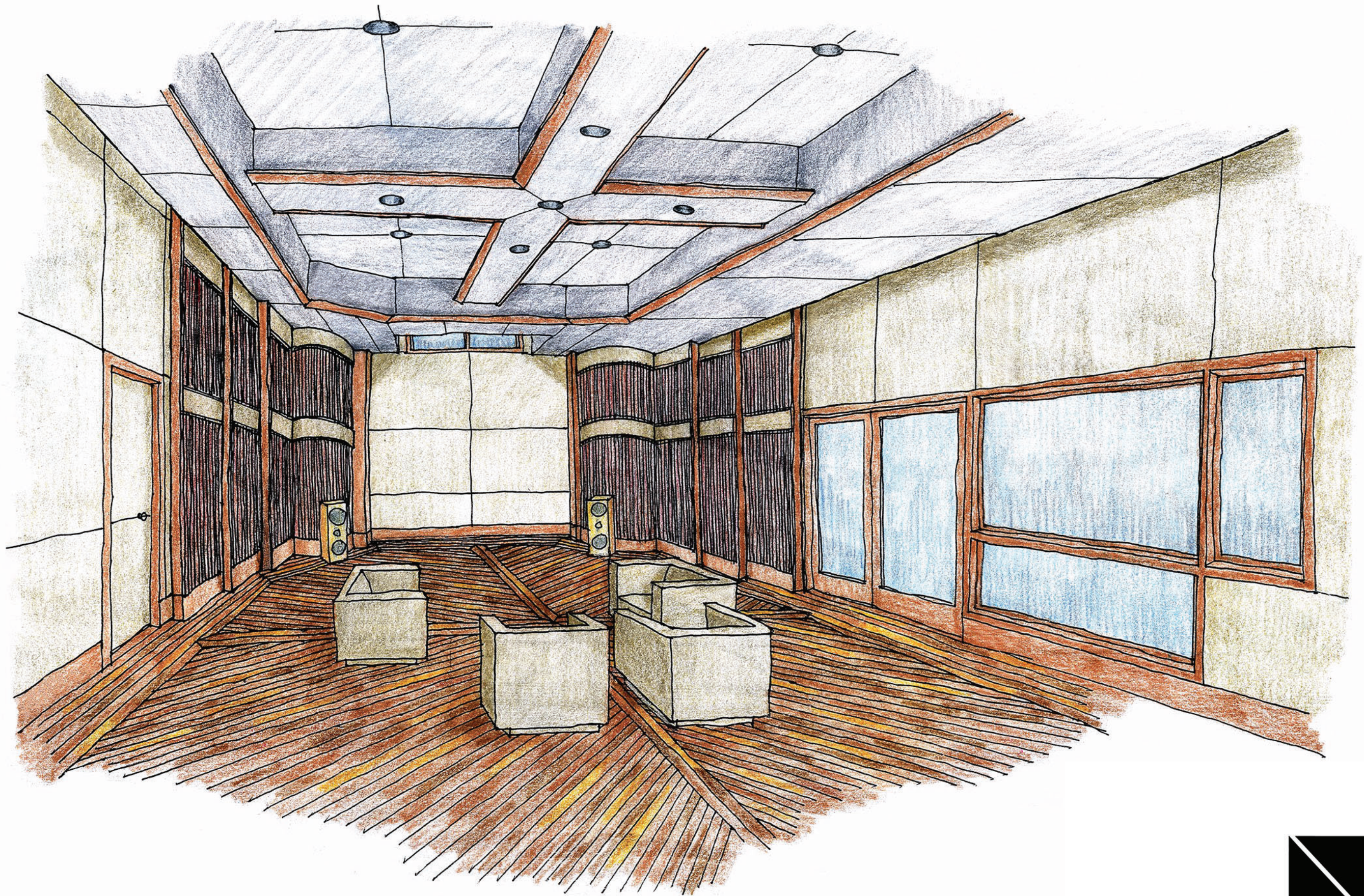

NIX GROUP
ARCHITECTS

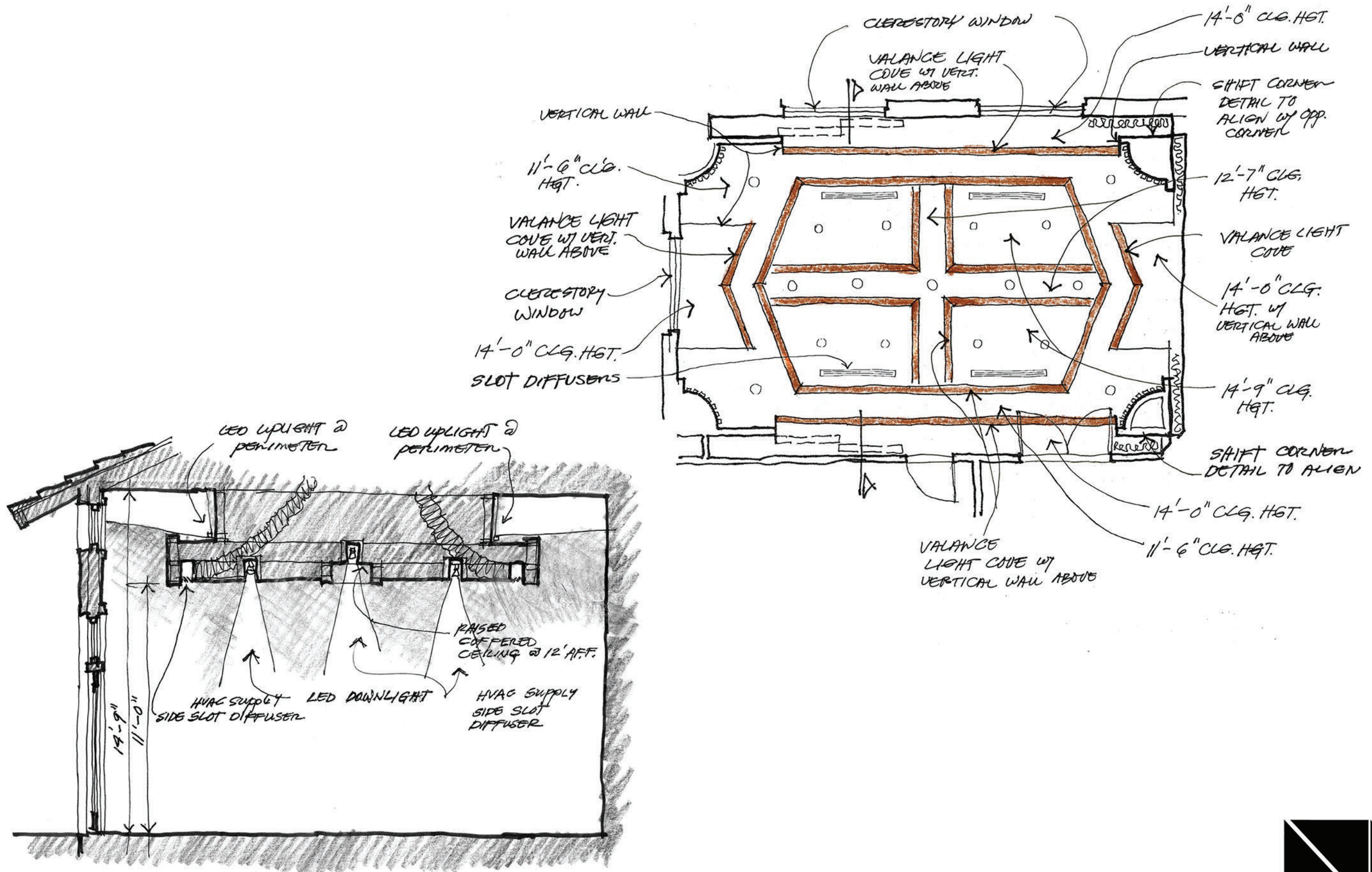

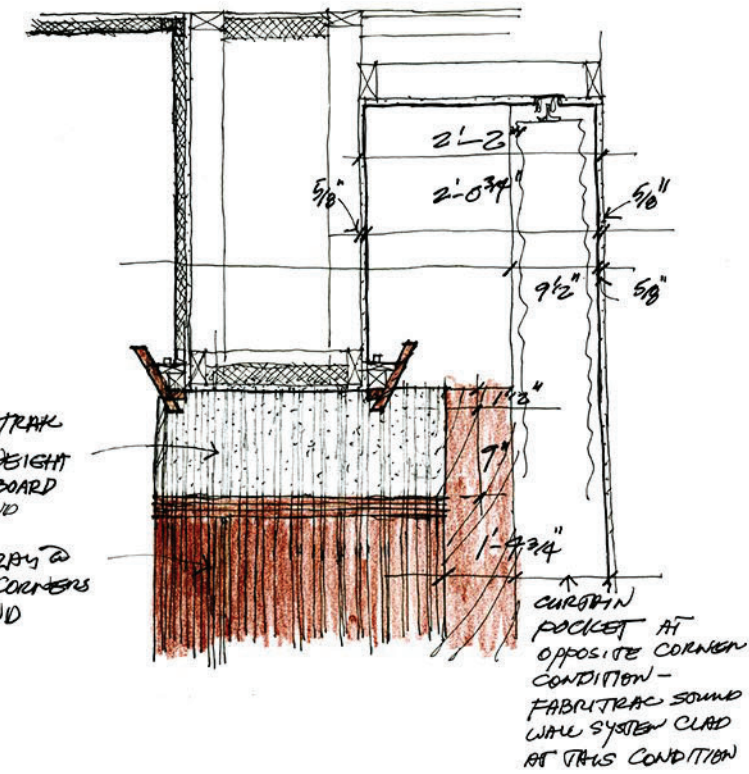
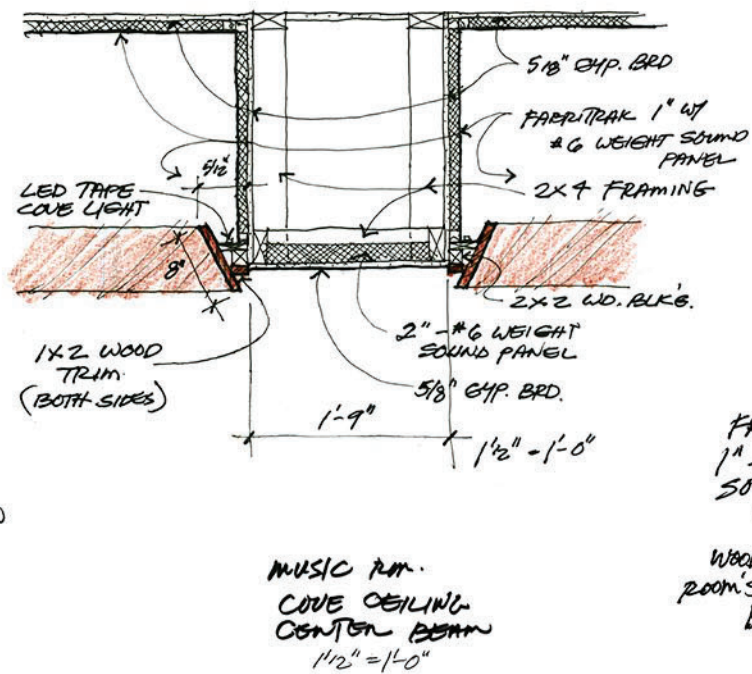
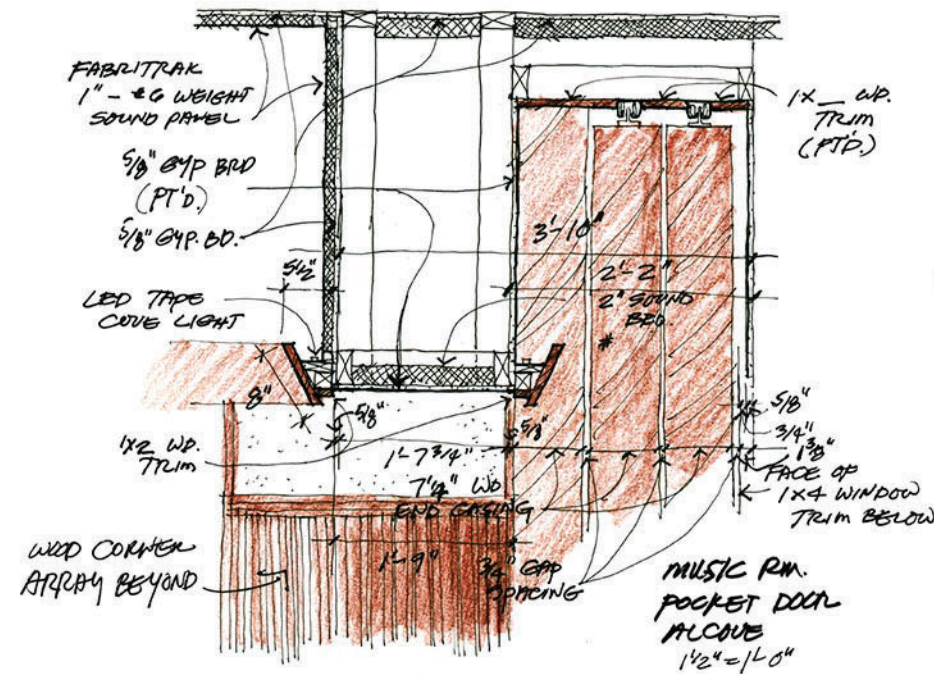

MUSIC ROOM - SEPARATE PANELS
 REAR VIEW OF SLIDING PANEL
 CREATED BY RECESS

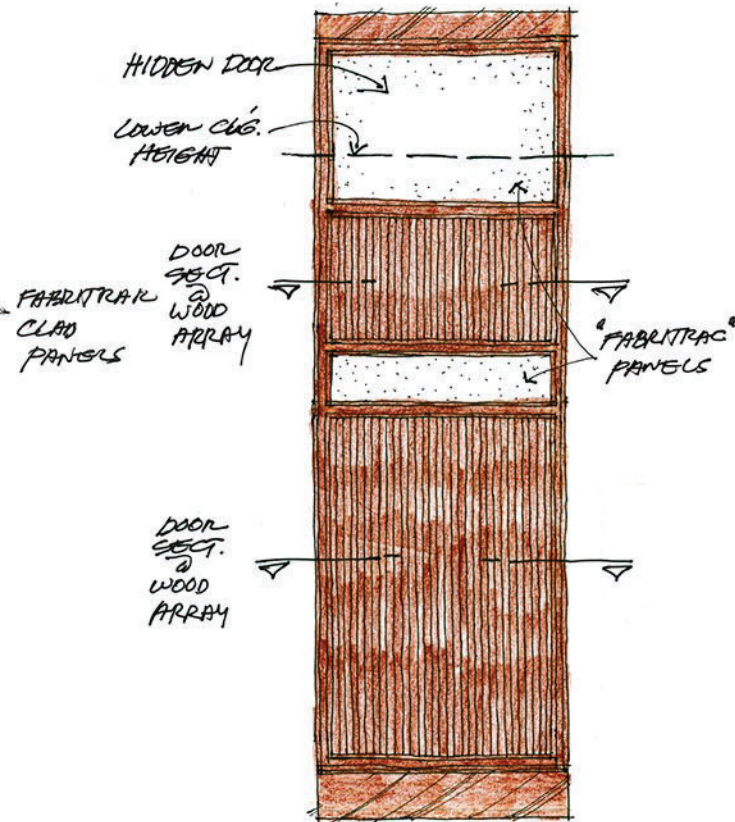

MUSIC ROOM - SEPARATE PANELS
 FRONT VIEW OF SLIDING PANEL
 CREATED BY RECESS

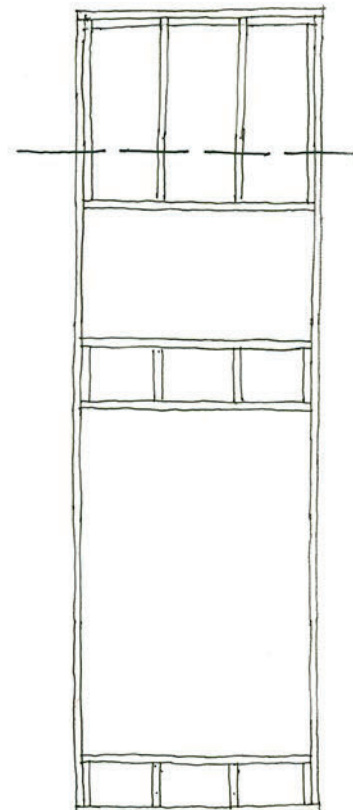

MUSIC ROOM - DESIGN TO STIFFEN
 VIEW OF 2X4 DOOR TO PREVENT
 HIDDEN FRAME RACKING

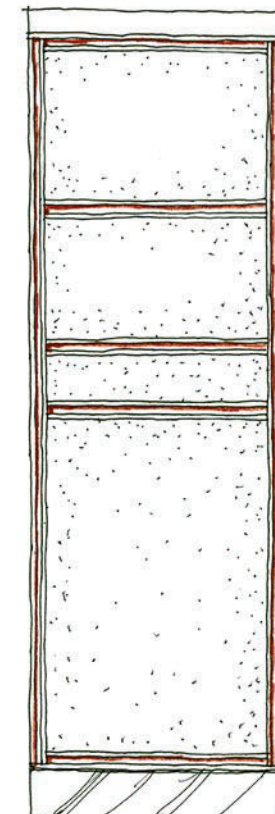

ALTERNATE CONTINUOUS EDGE
 MUSIC ROOM - RECESS DESIGN
 REAR VIEW OF SLIDING PANEL

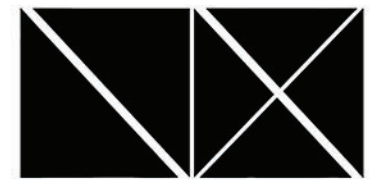

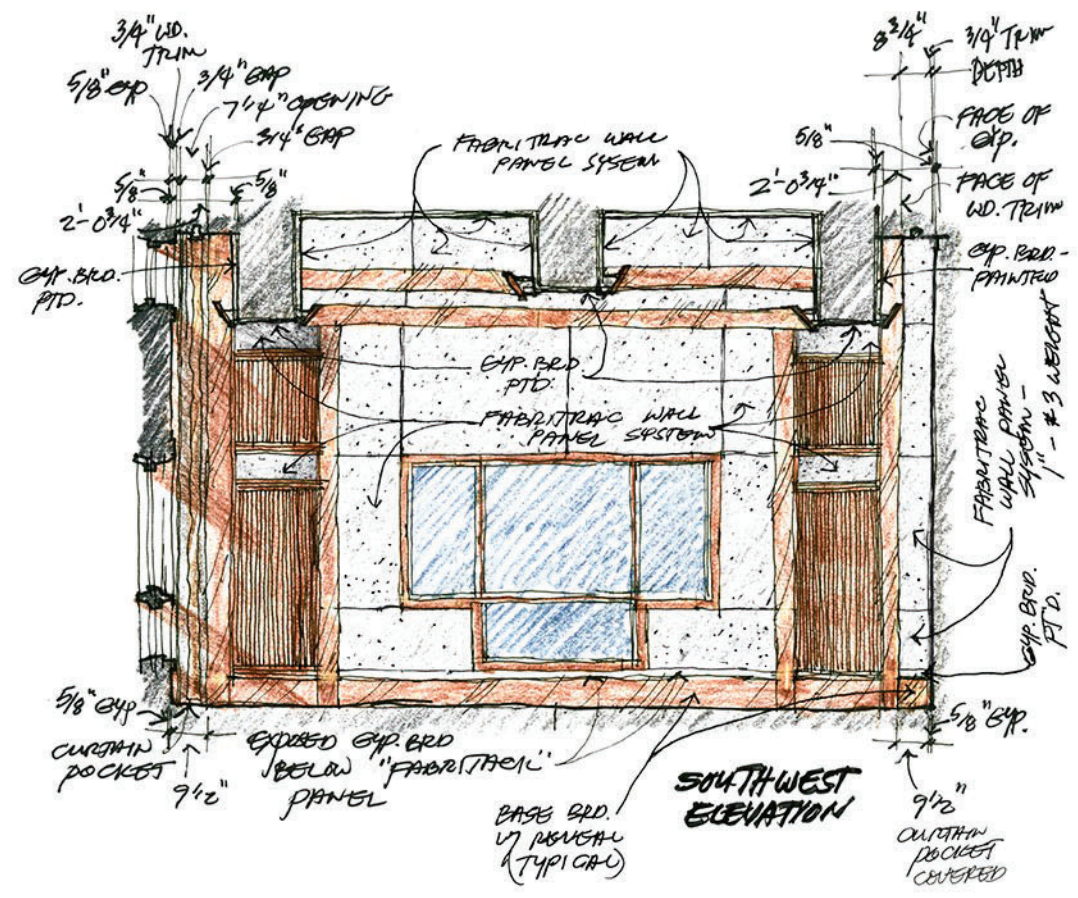
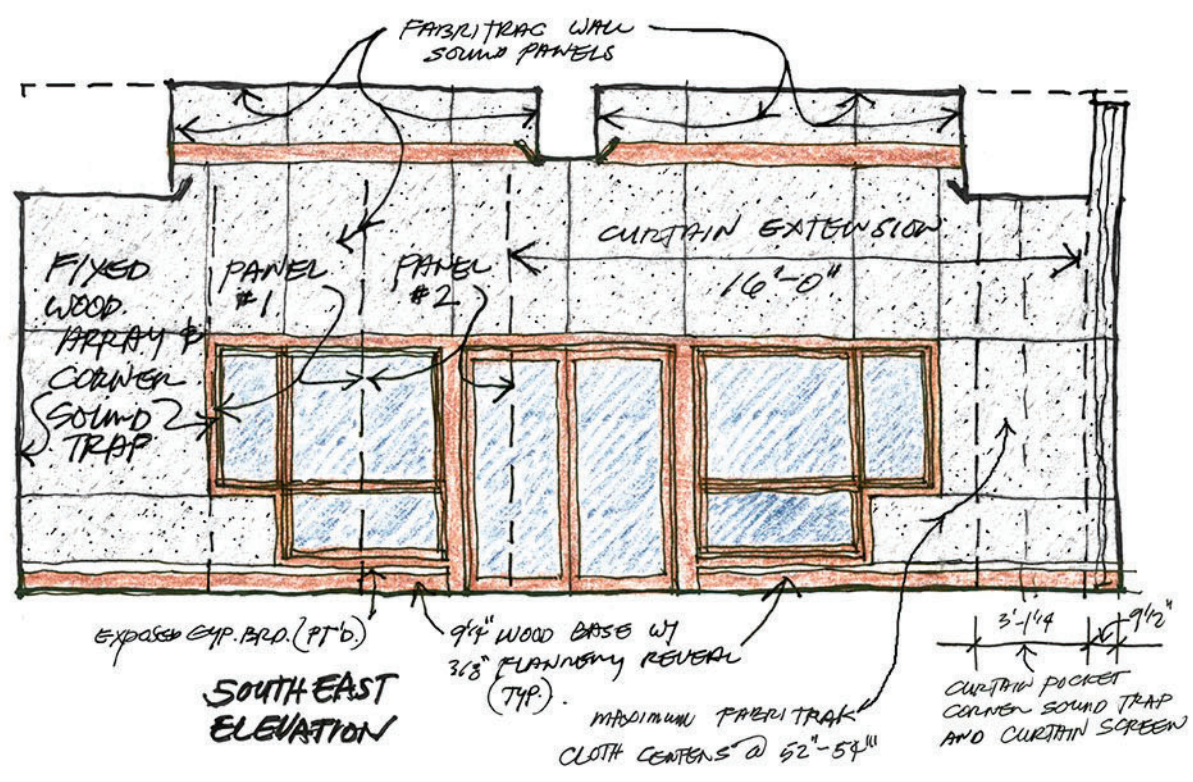
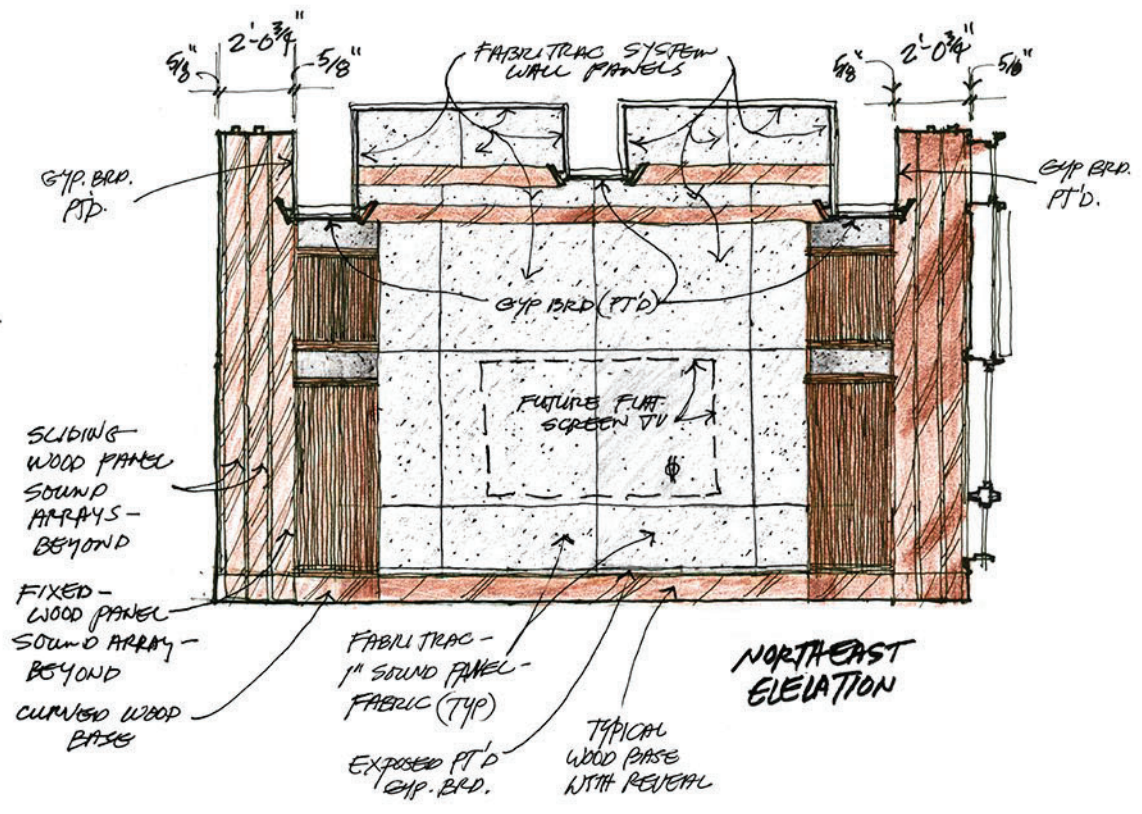
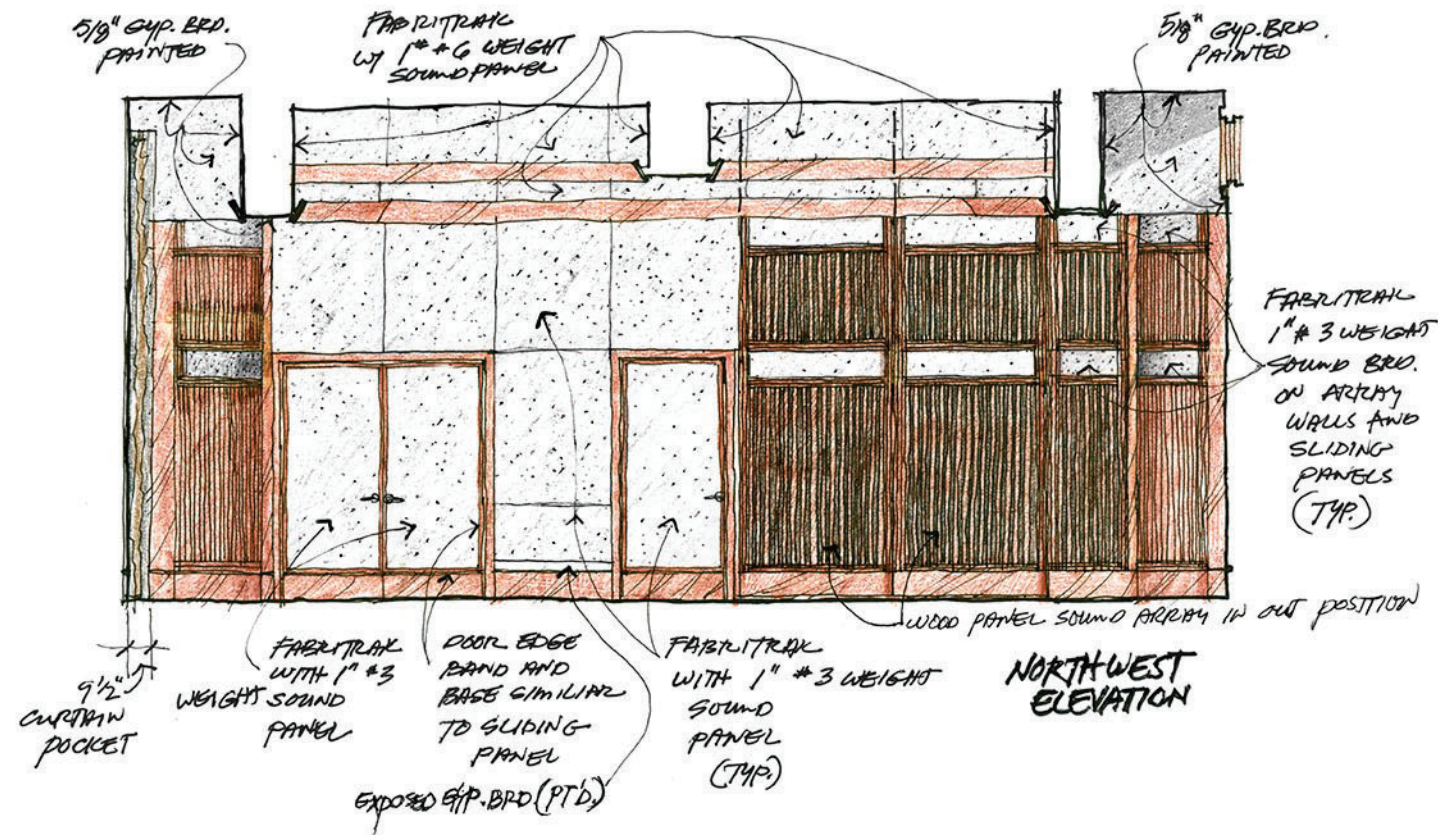

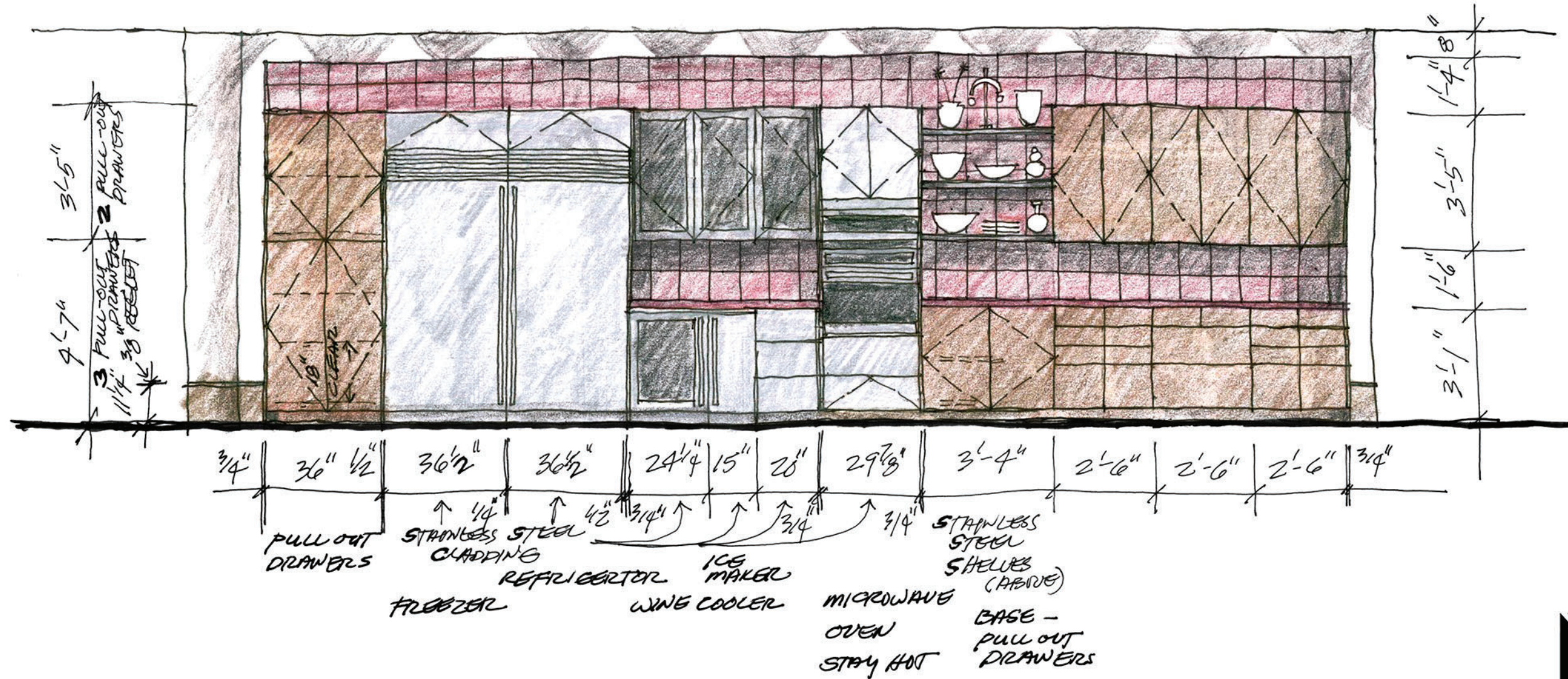
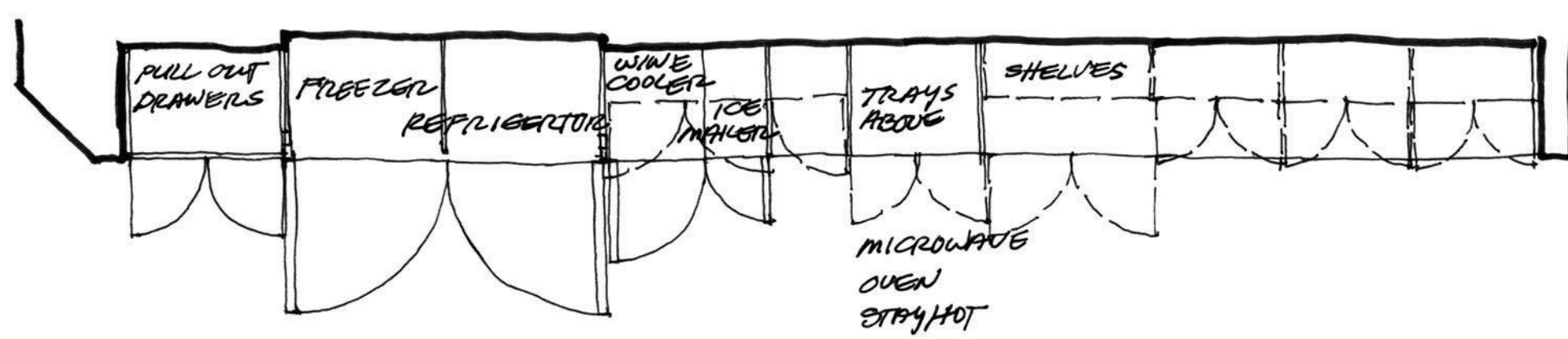



9 1/2" DEPTH
BOOK SHELVES
WOOD SPECIES
#3

12" DEPTH
BOOK SHELVES
WOOD SPECIES
#2

15" DEPTH
BOOK SHELVES
WOOD SPECIES
#1

WOOD SPECIES
#3

WOOD SPECIES
#2

WOOD SPECIES
#1

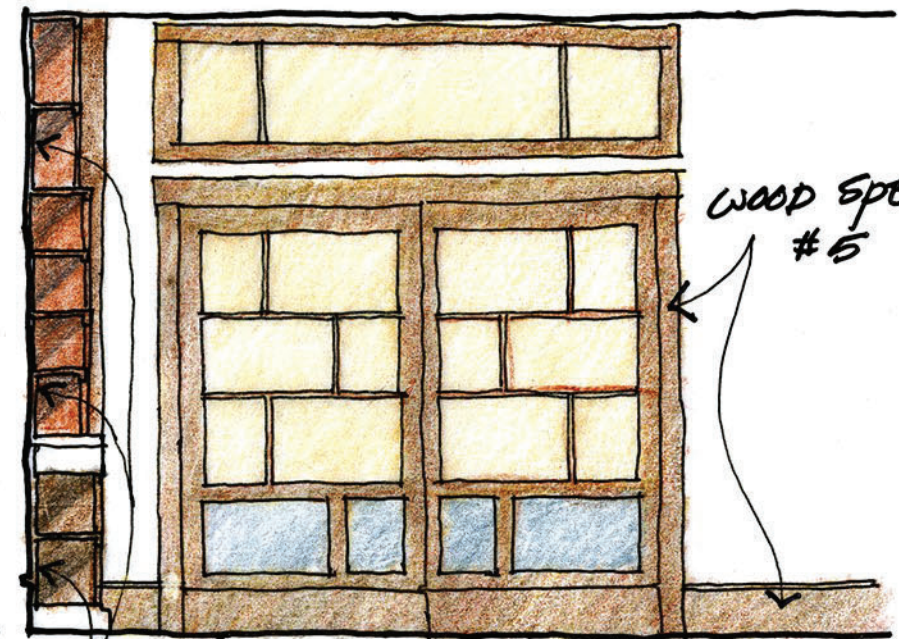

WOOD SPECIES
#5

WOOD SPECIES #5

OPTION #1 -
ALL OPEN CABINETS'
BACK PANELS -
WOOD SPECIES #4

OPTION #1 -
ALL OPEN CABINETS'
BACK PANELS -
WOOD SPECIES #4

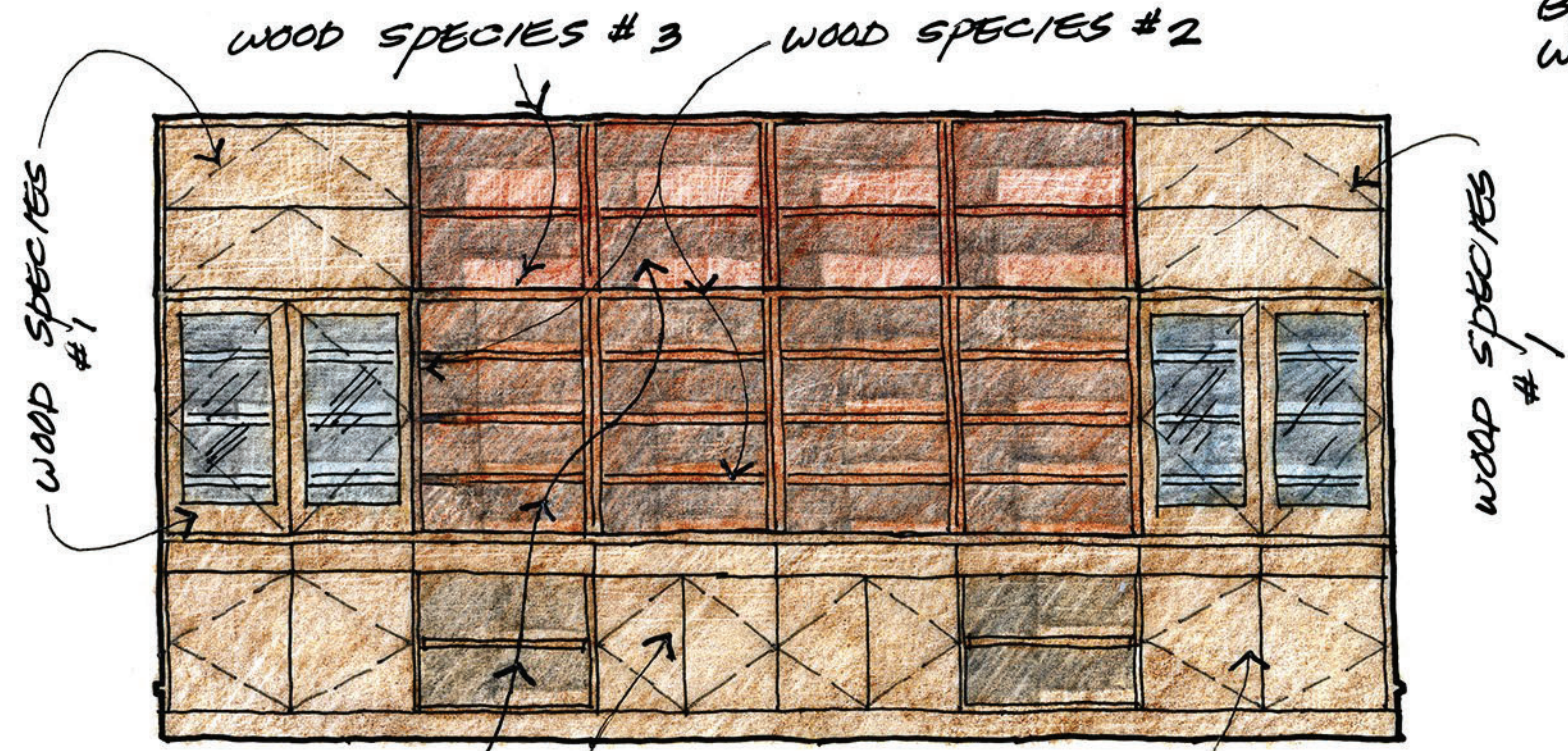

WOOD SPECIES #3

WOOD SPECIES #2

WOOD SPECIES
#1

WOOD SPECIES
#1

OPTION #1 - ALL OPEN CABINETS'
BACK PANELS WOOD SPECIES #4

WOOD SPECIES #1

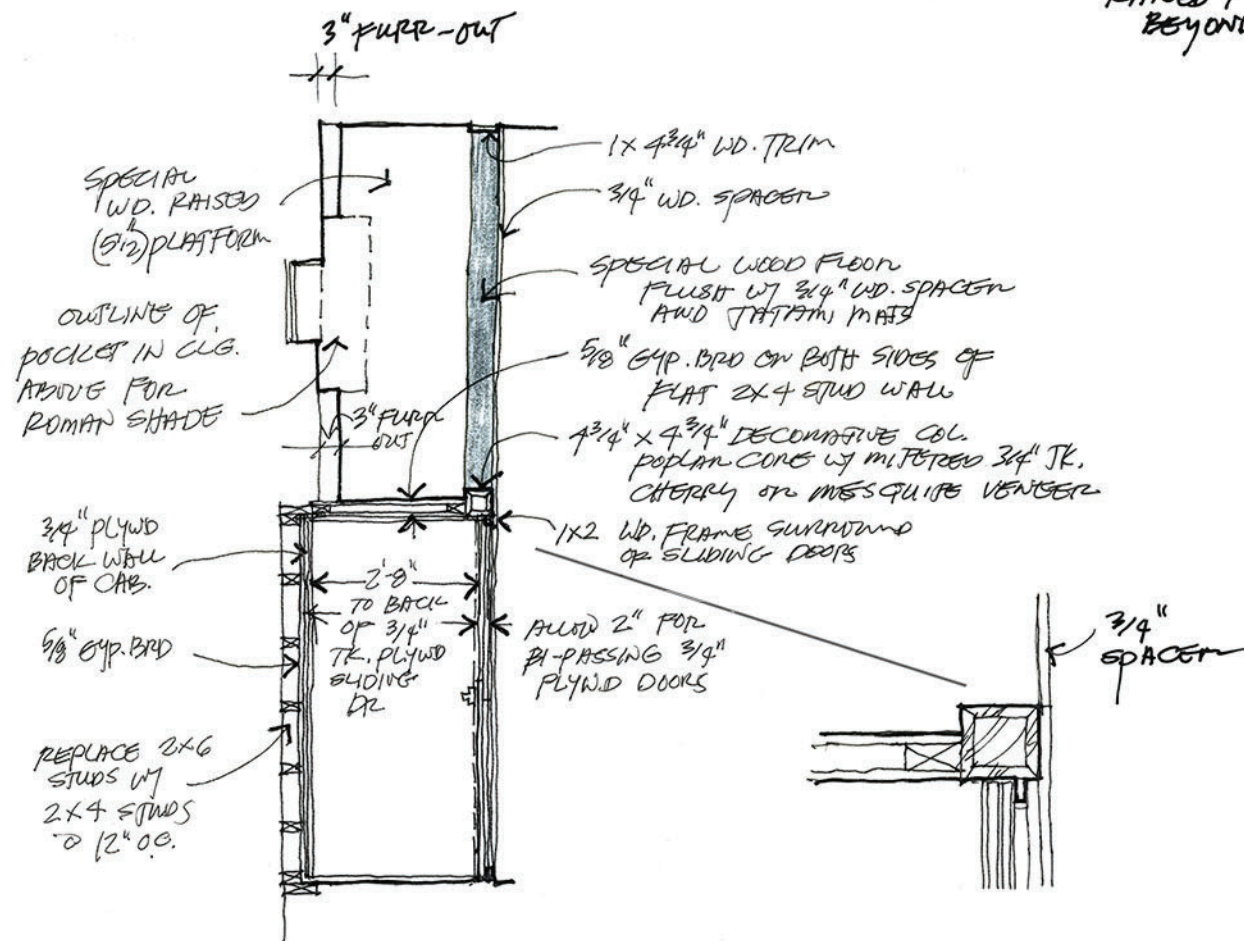
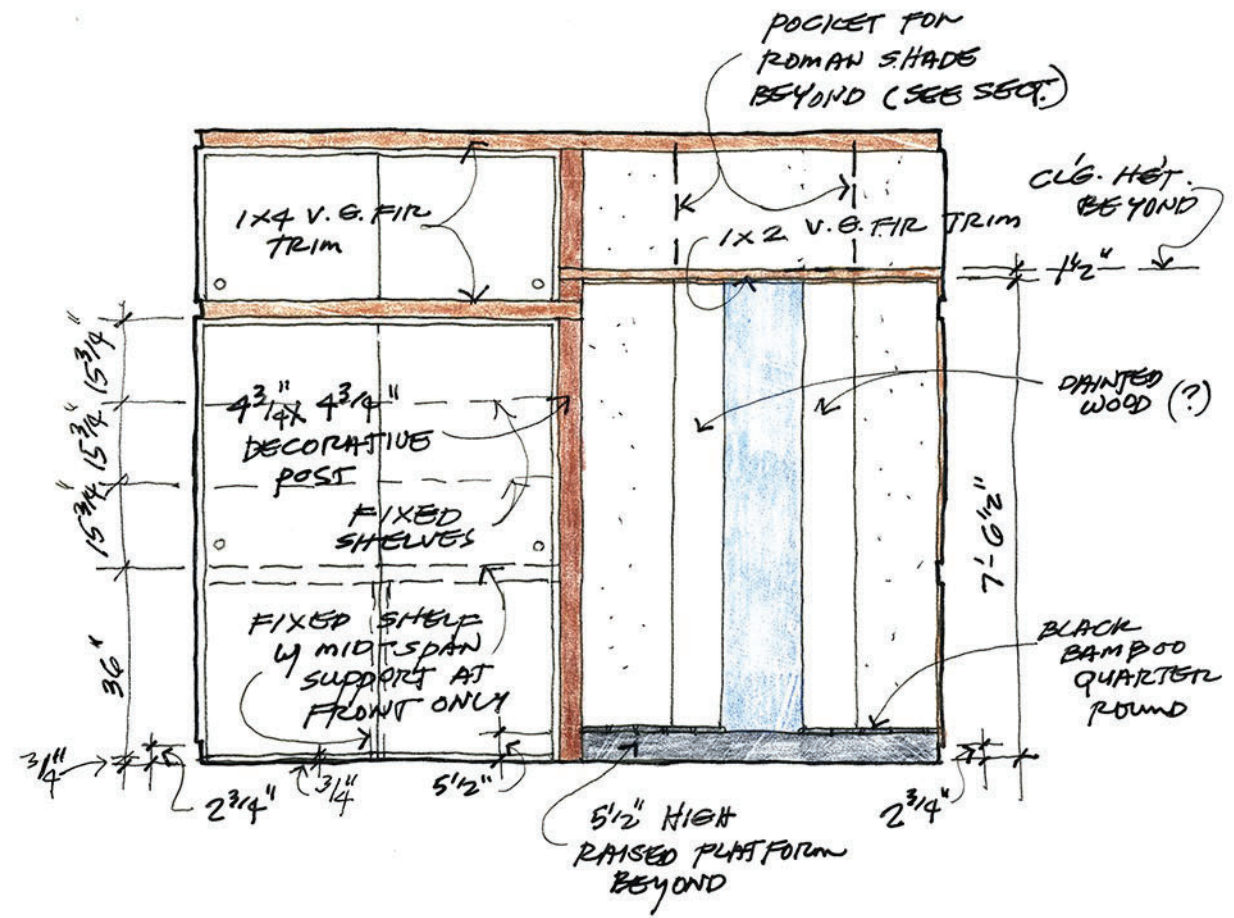
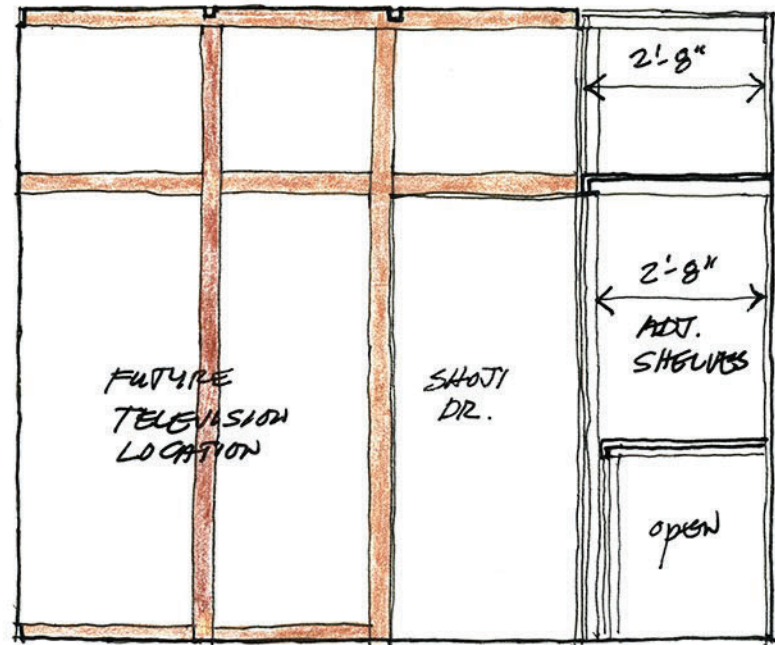

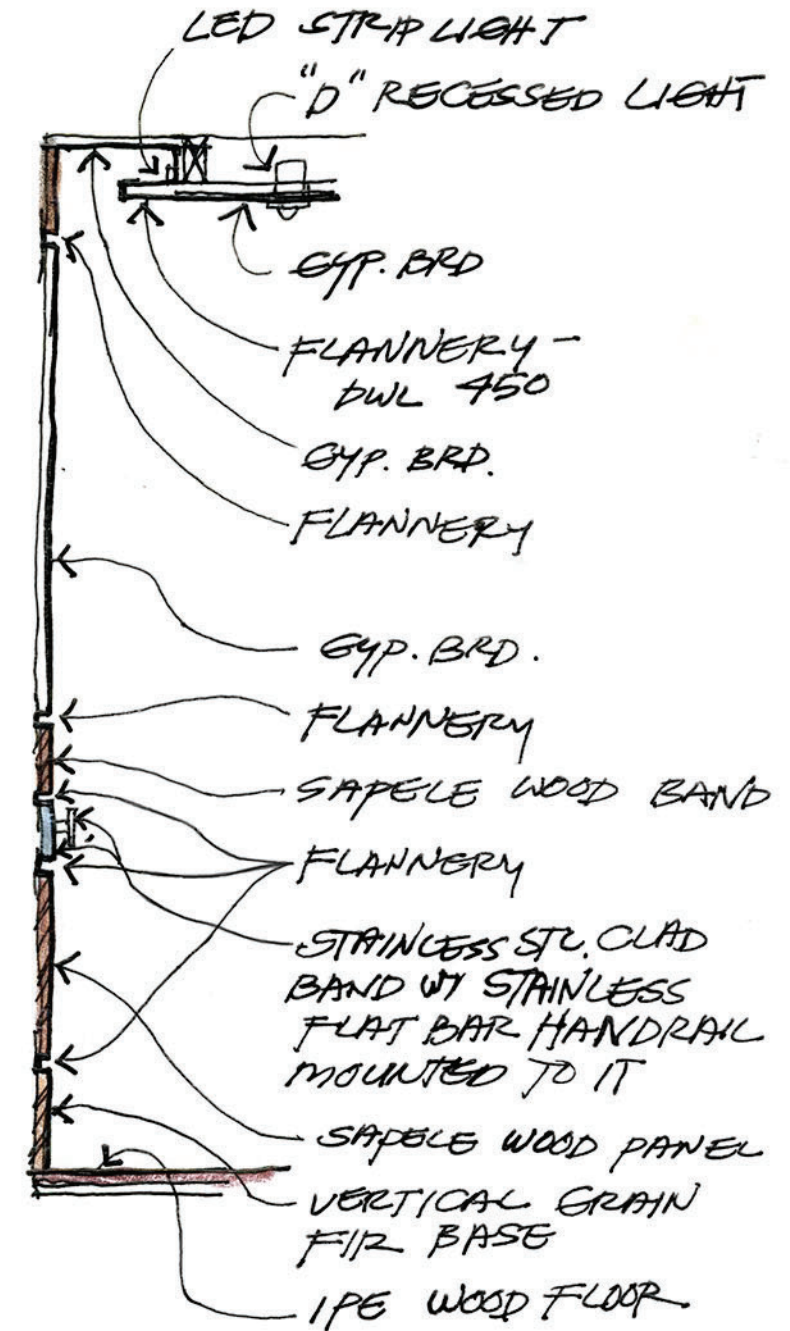
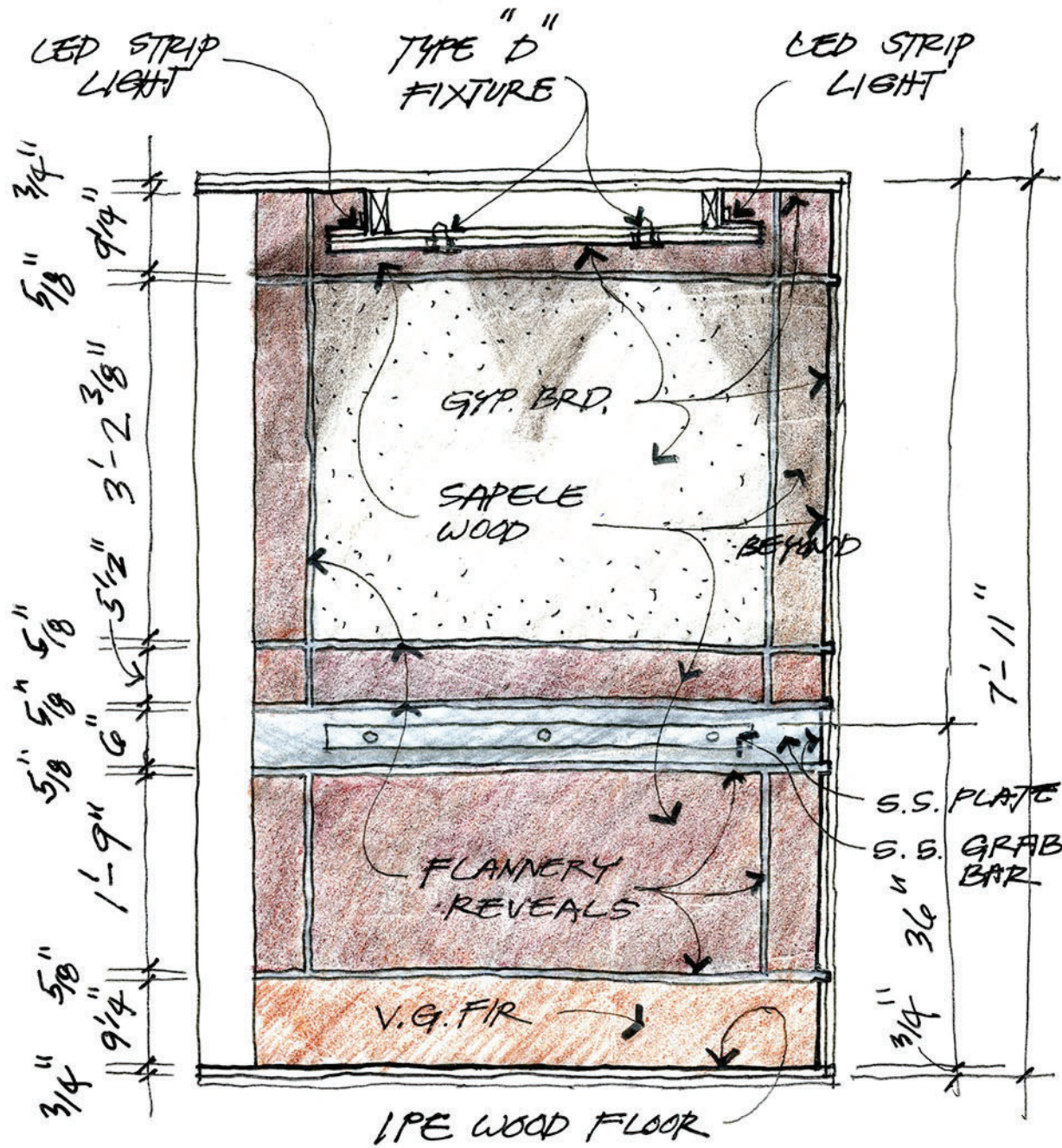
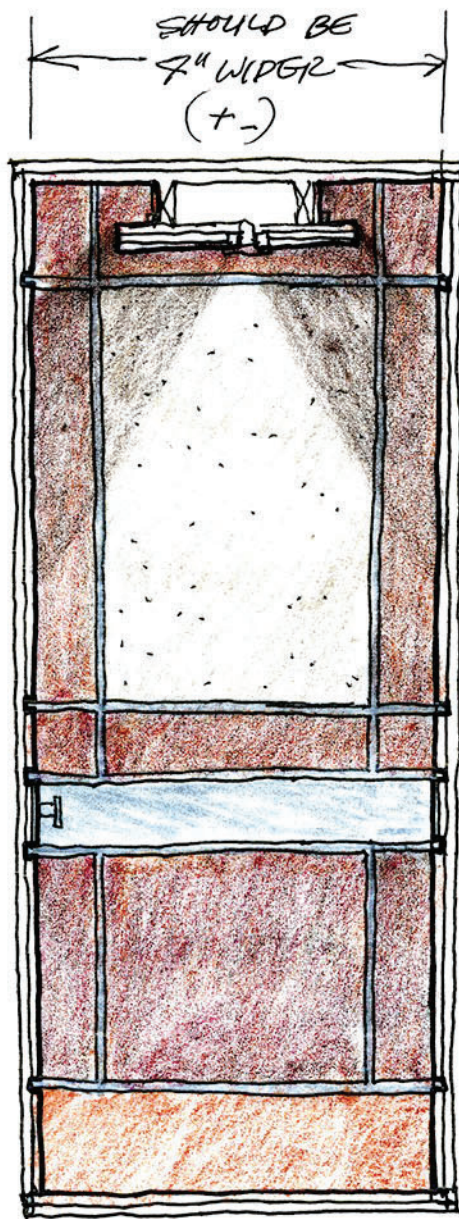

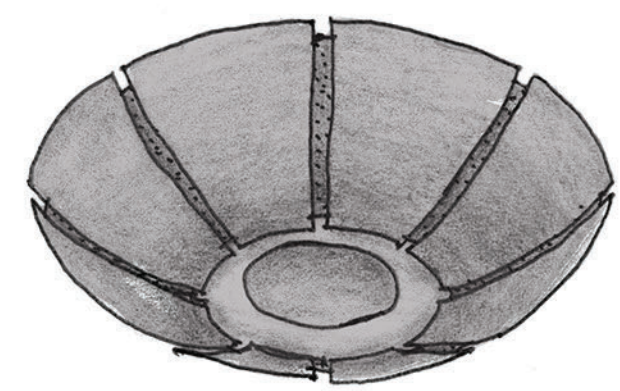
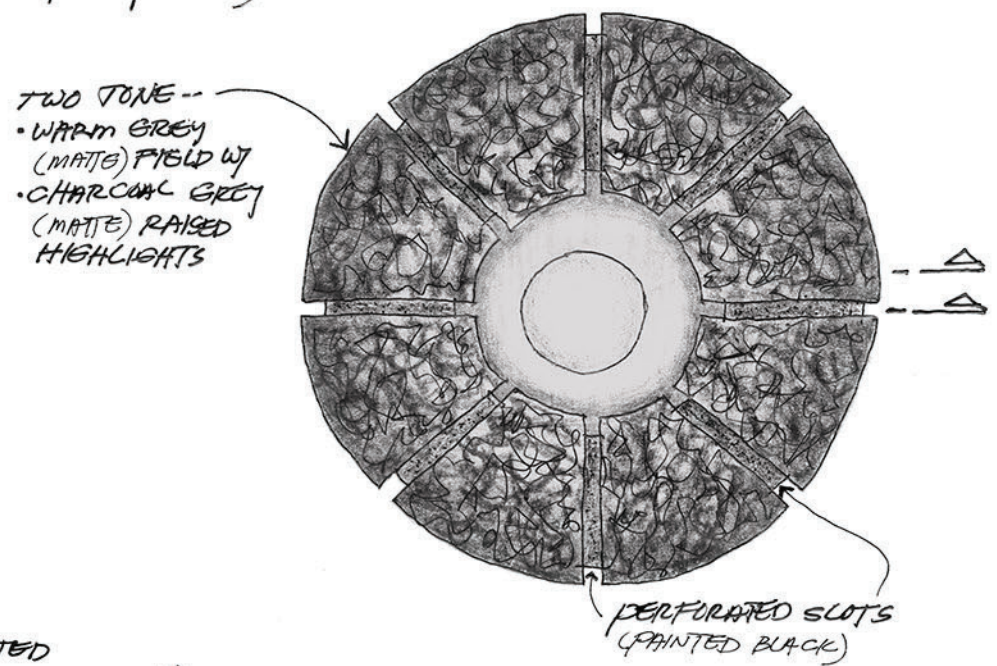
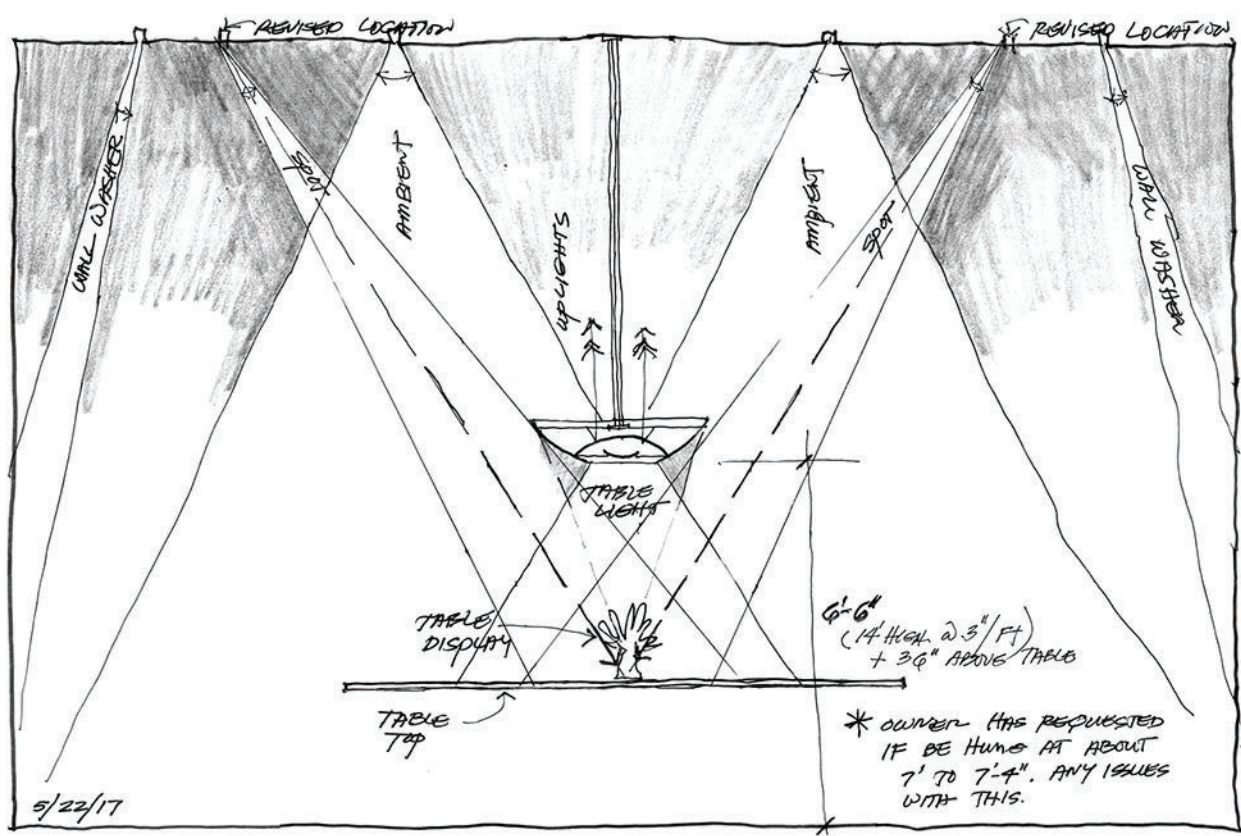
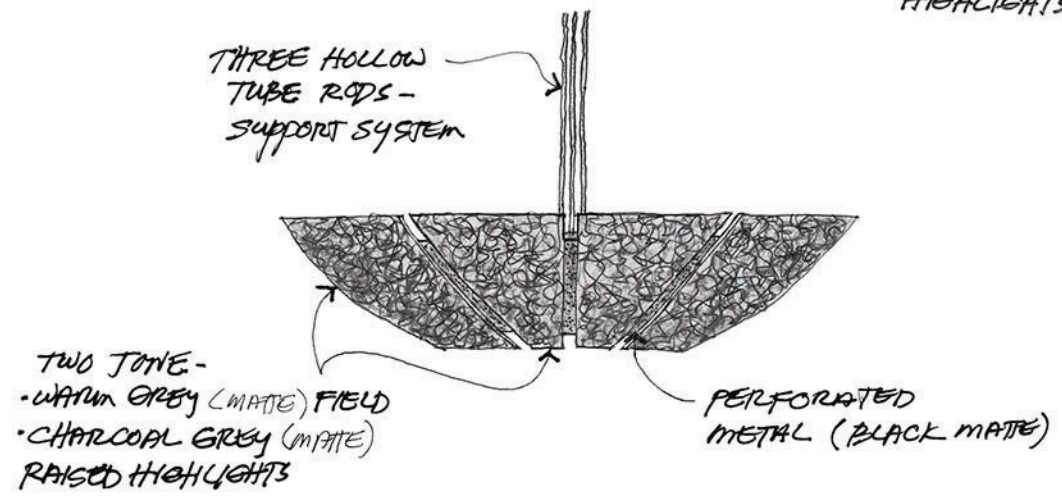
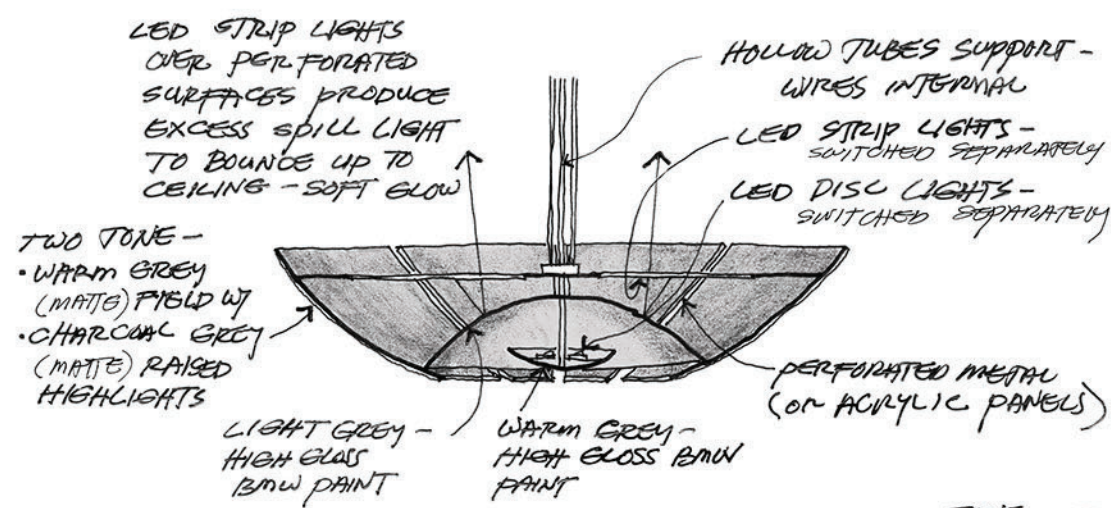
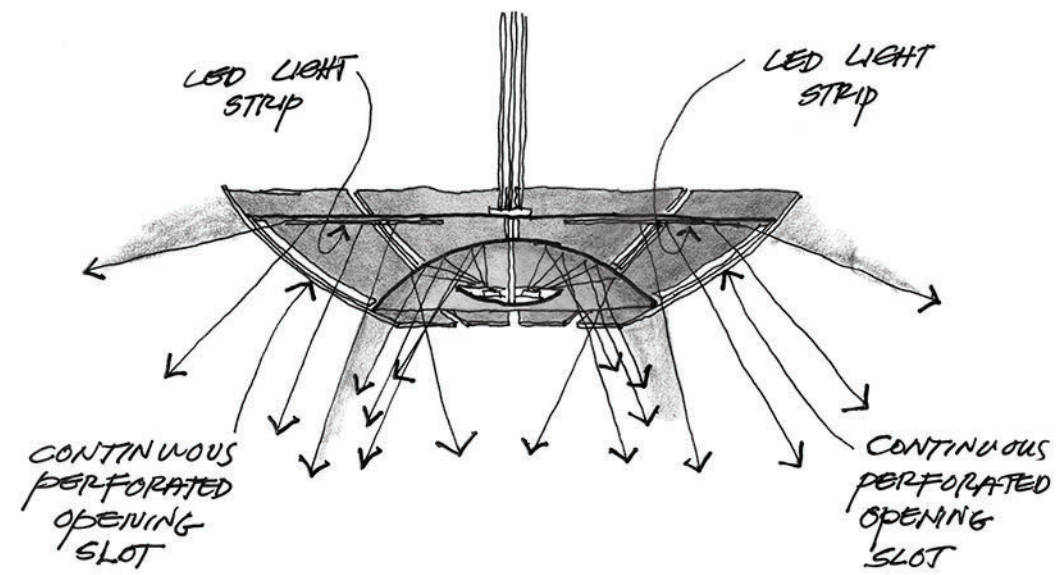

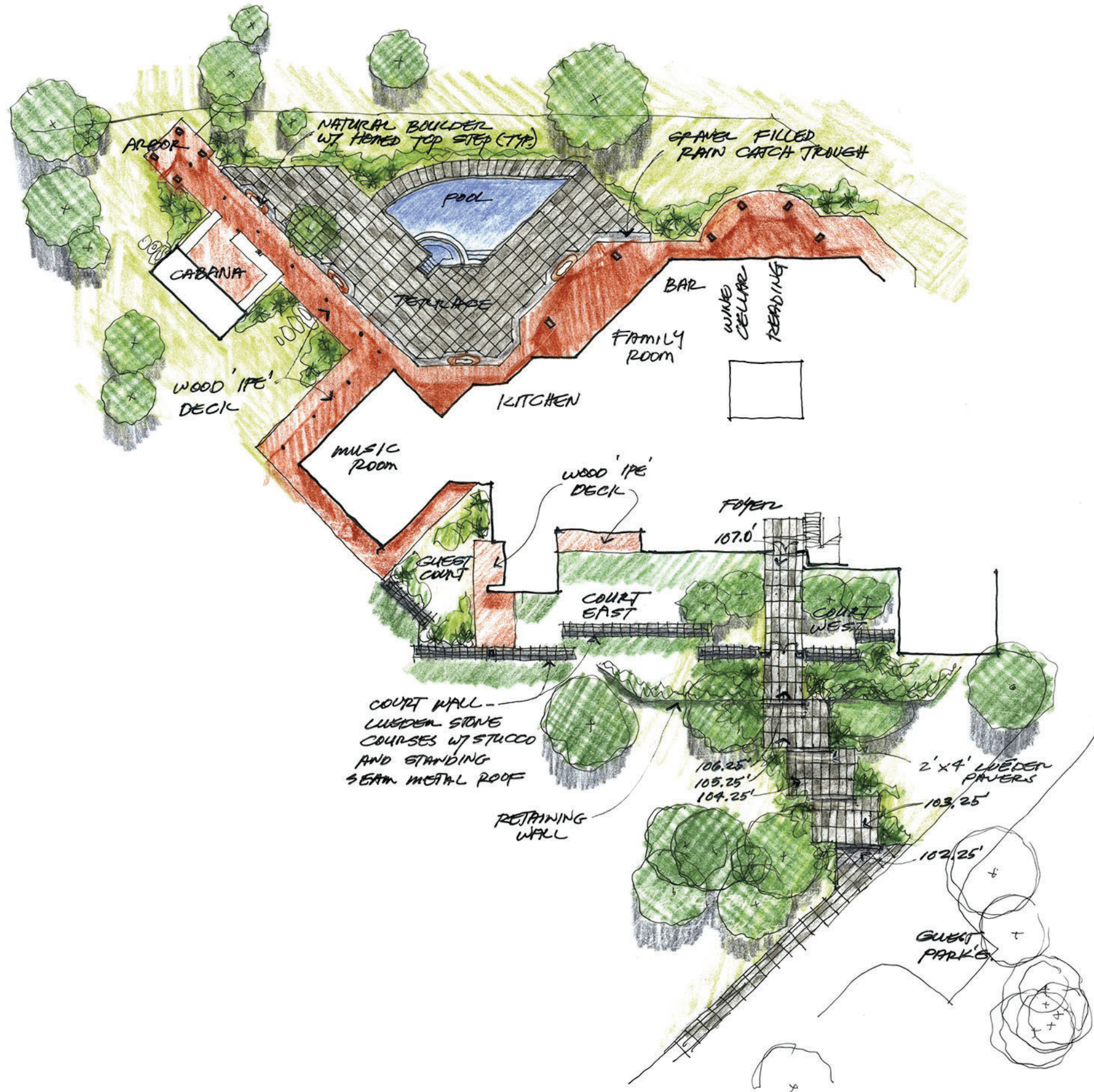

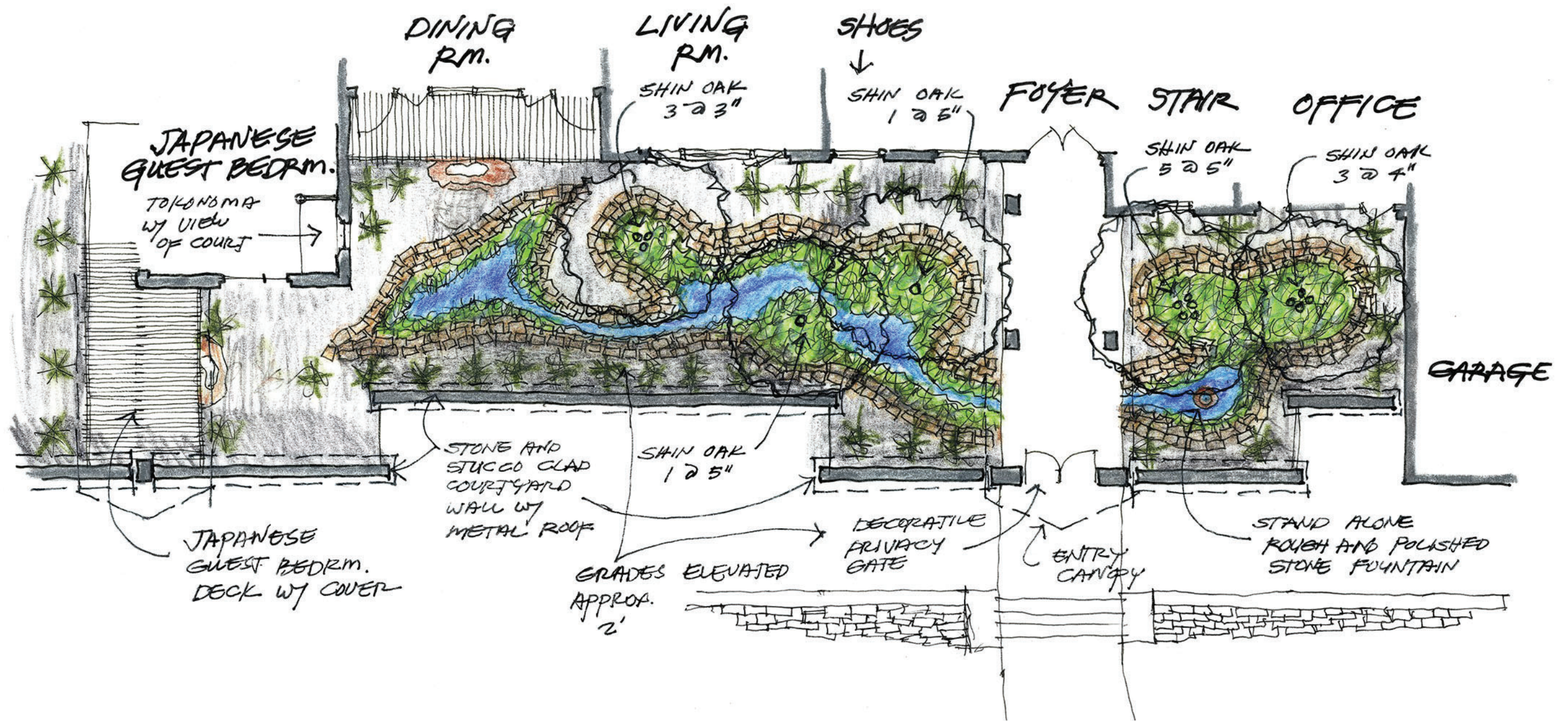

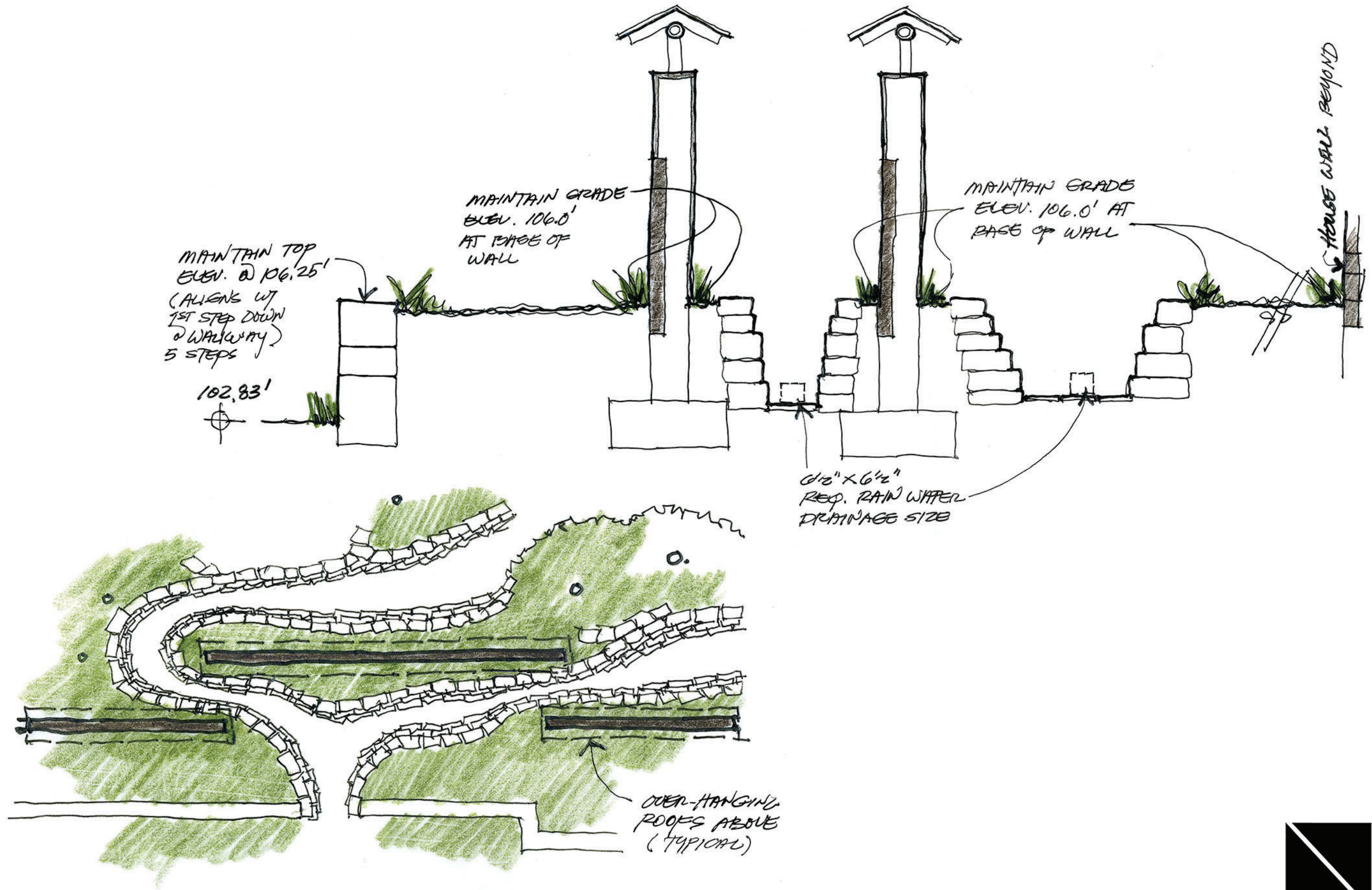

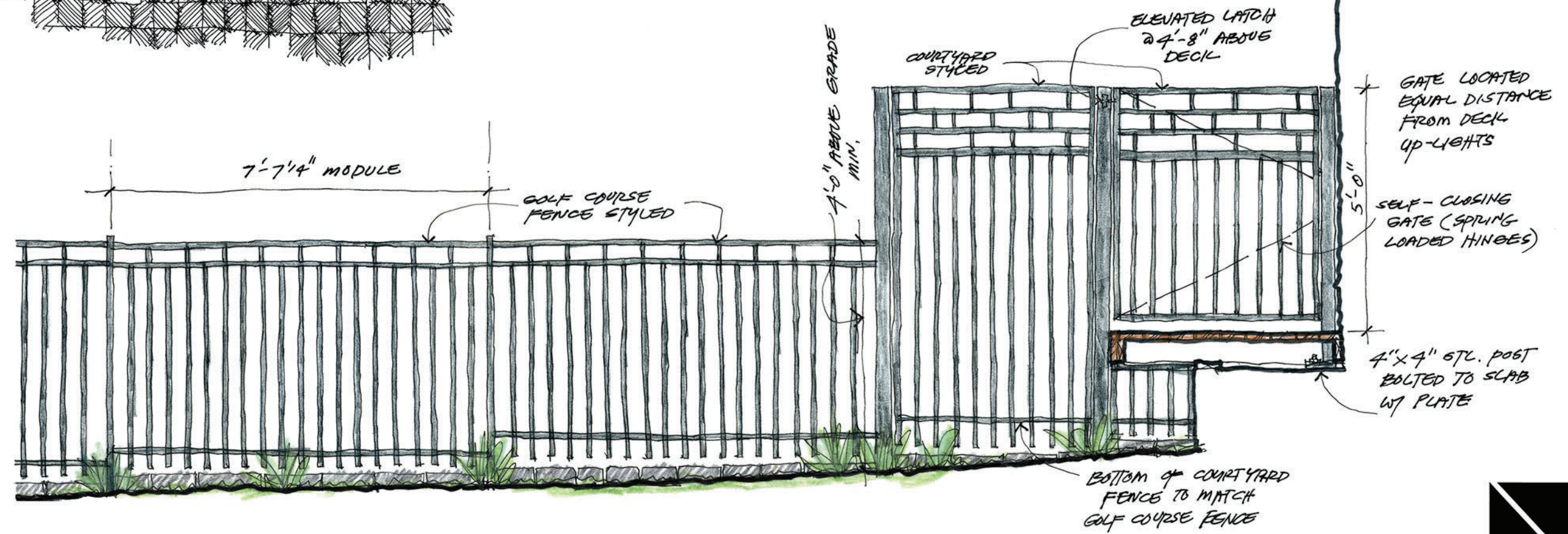
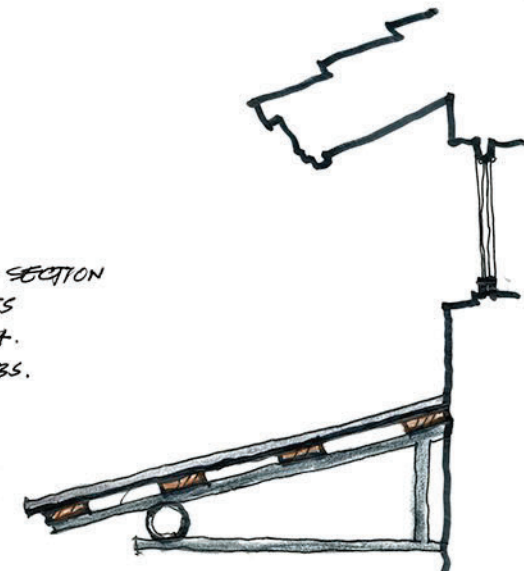
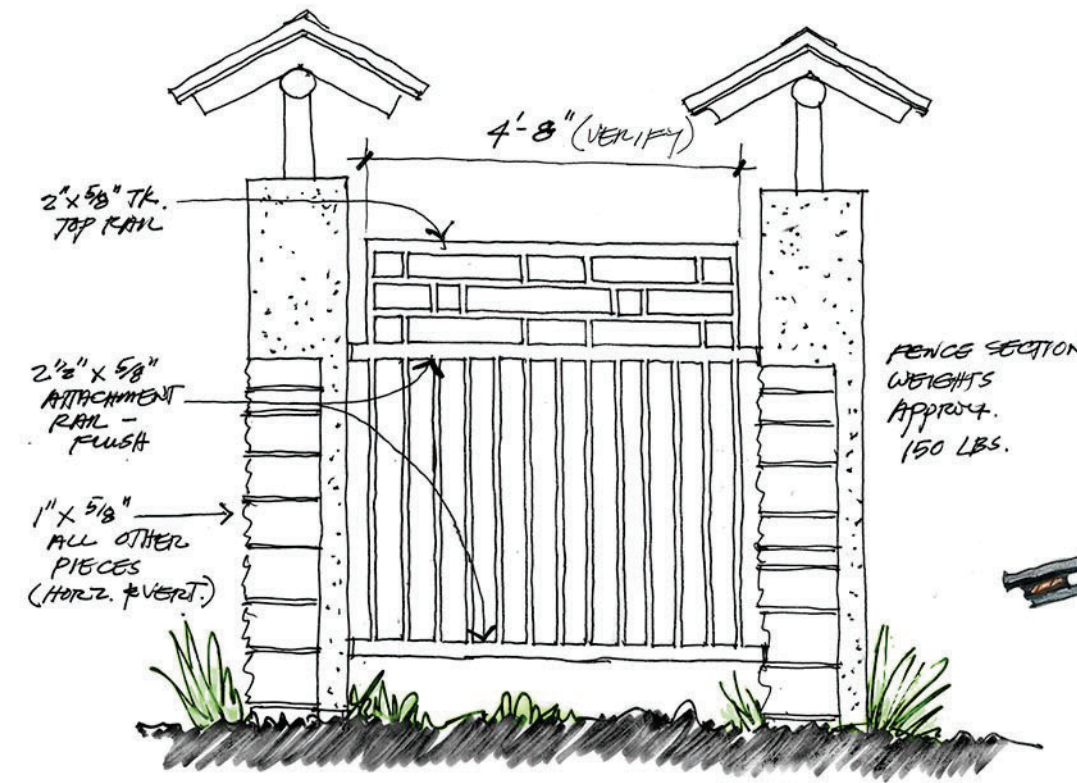
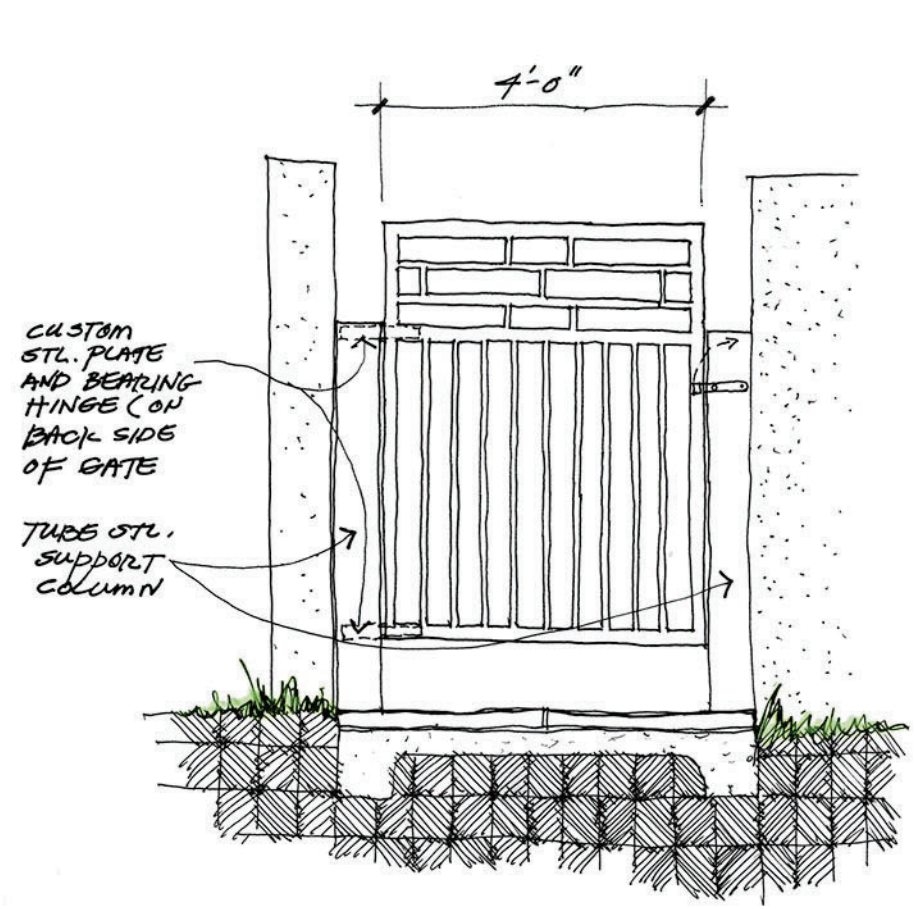

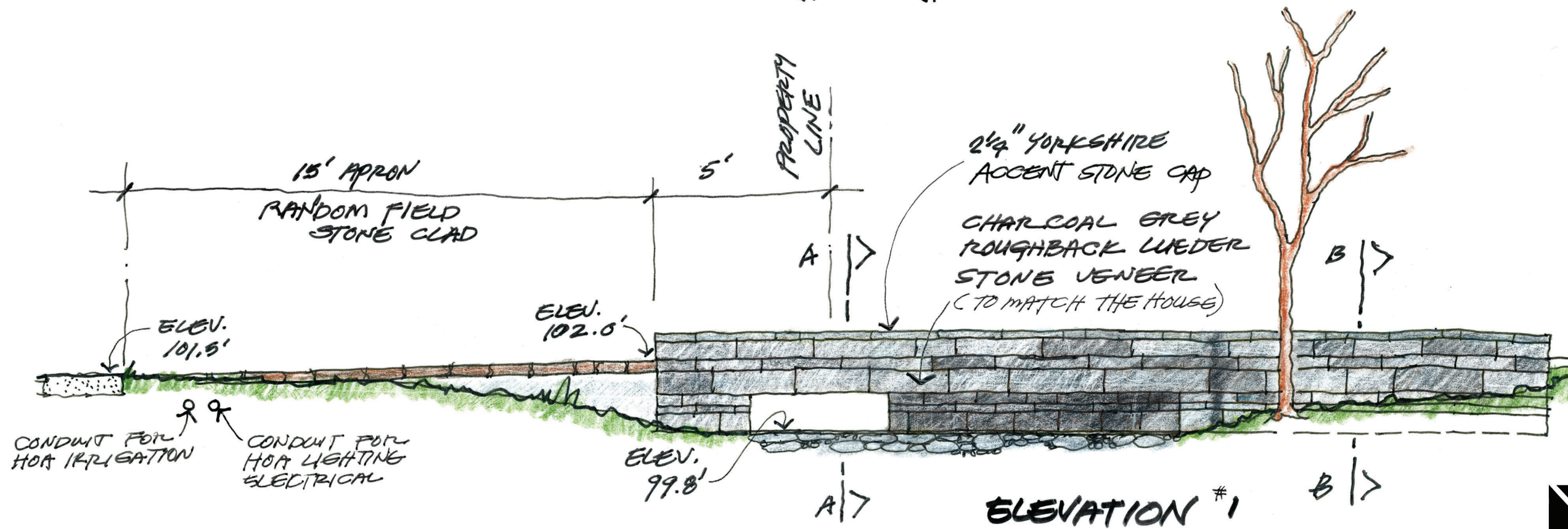
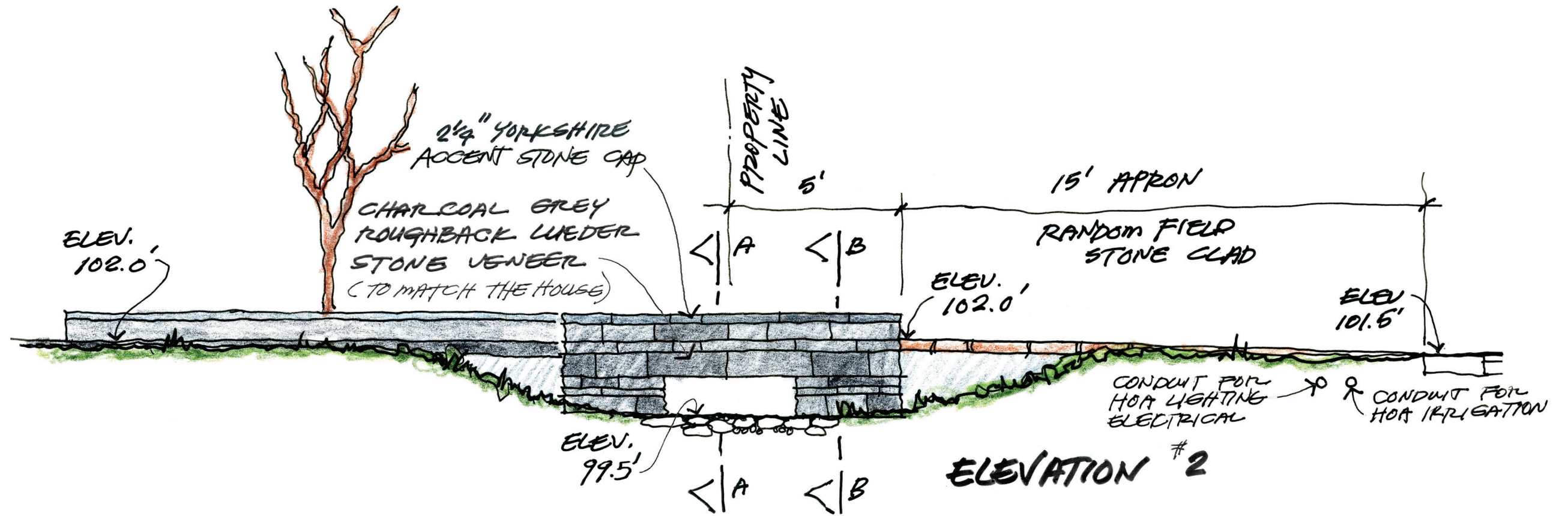

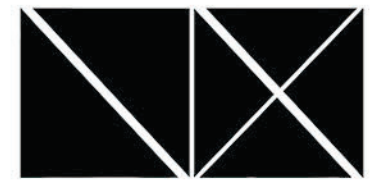
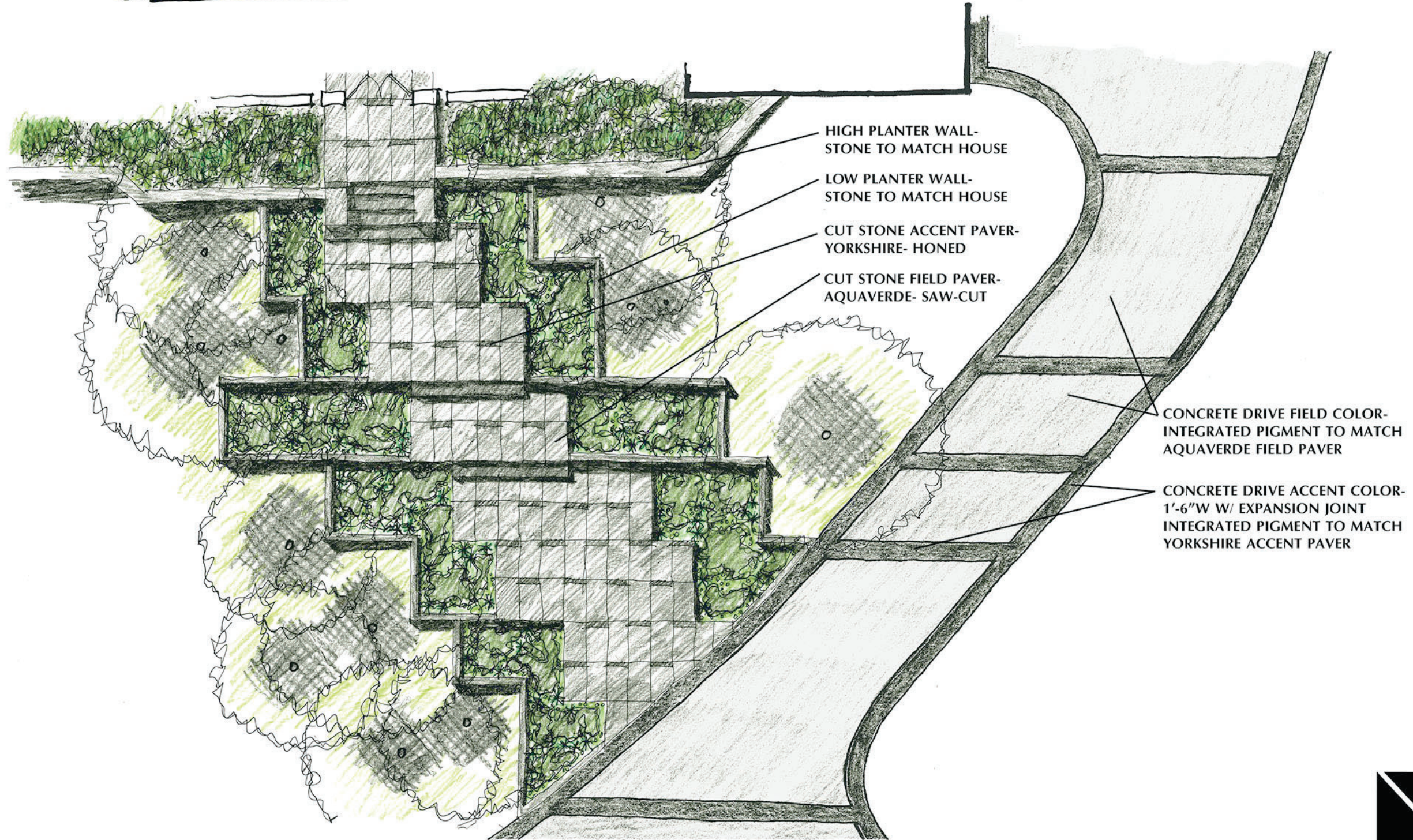
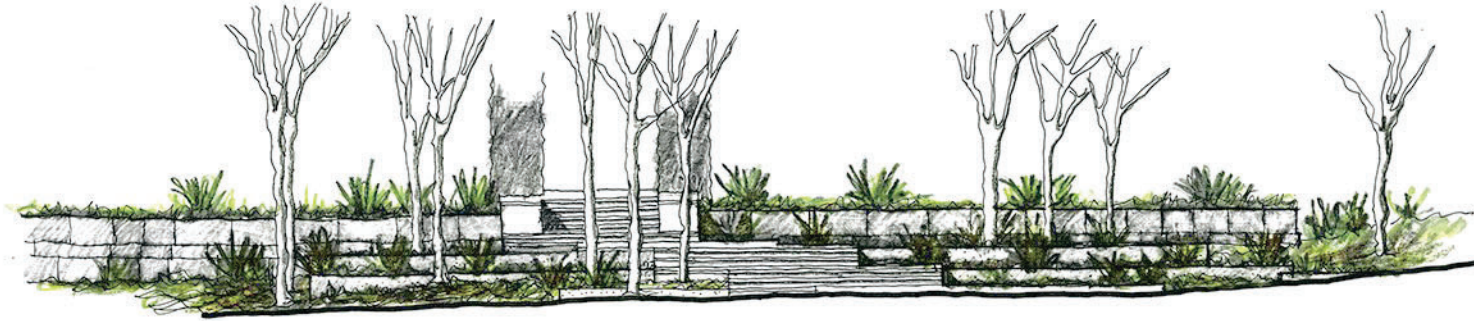

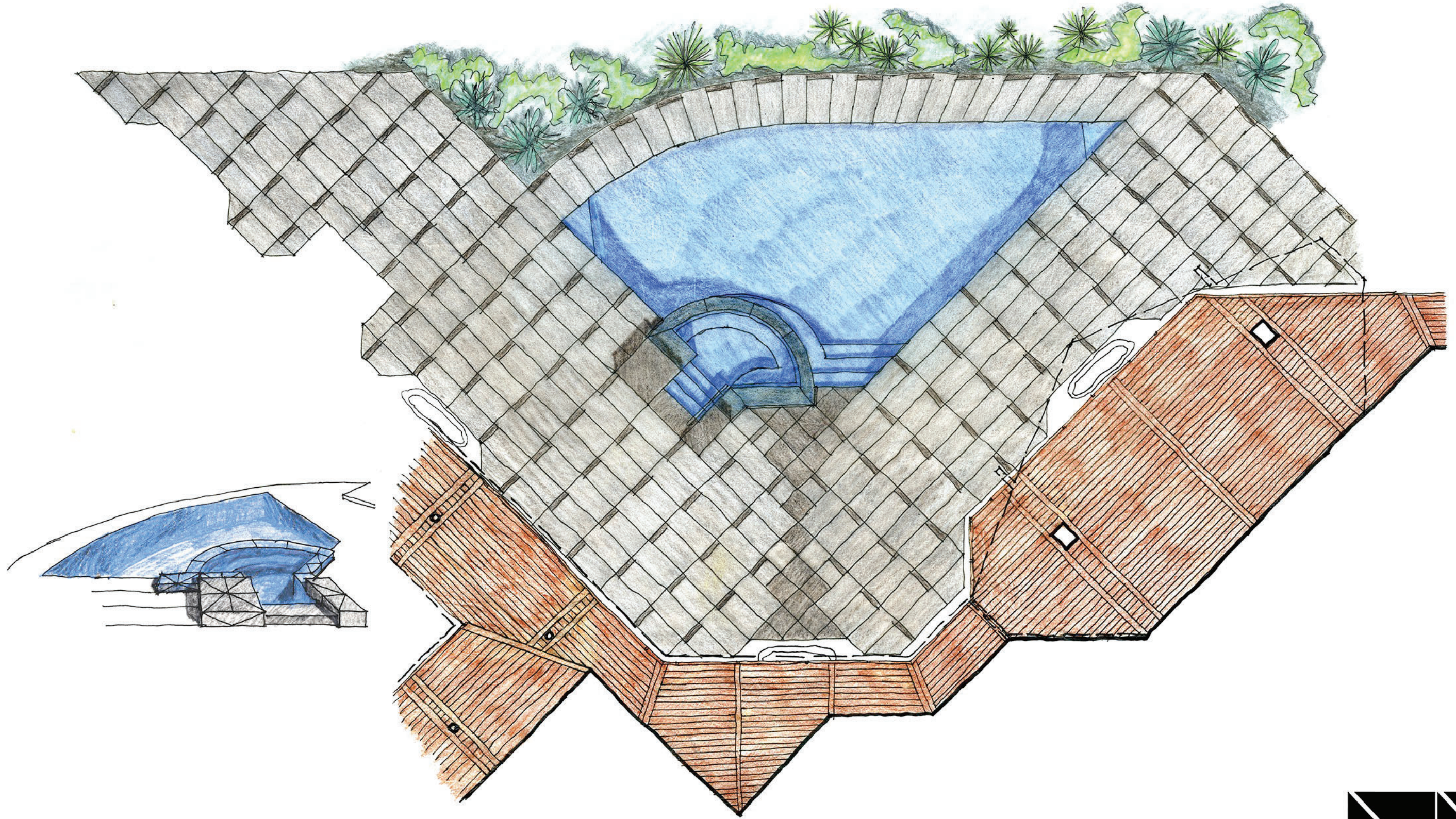

NIX GROUP
ARCHITECTS

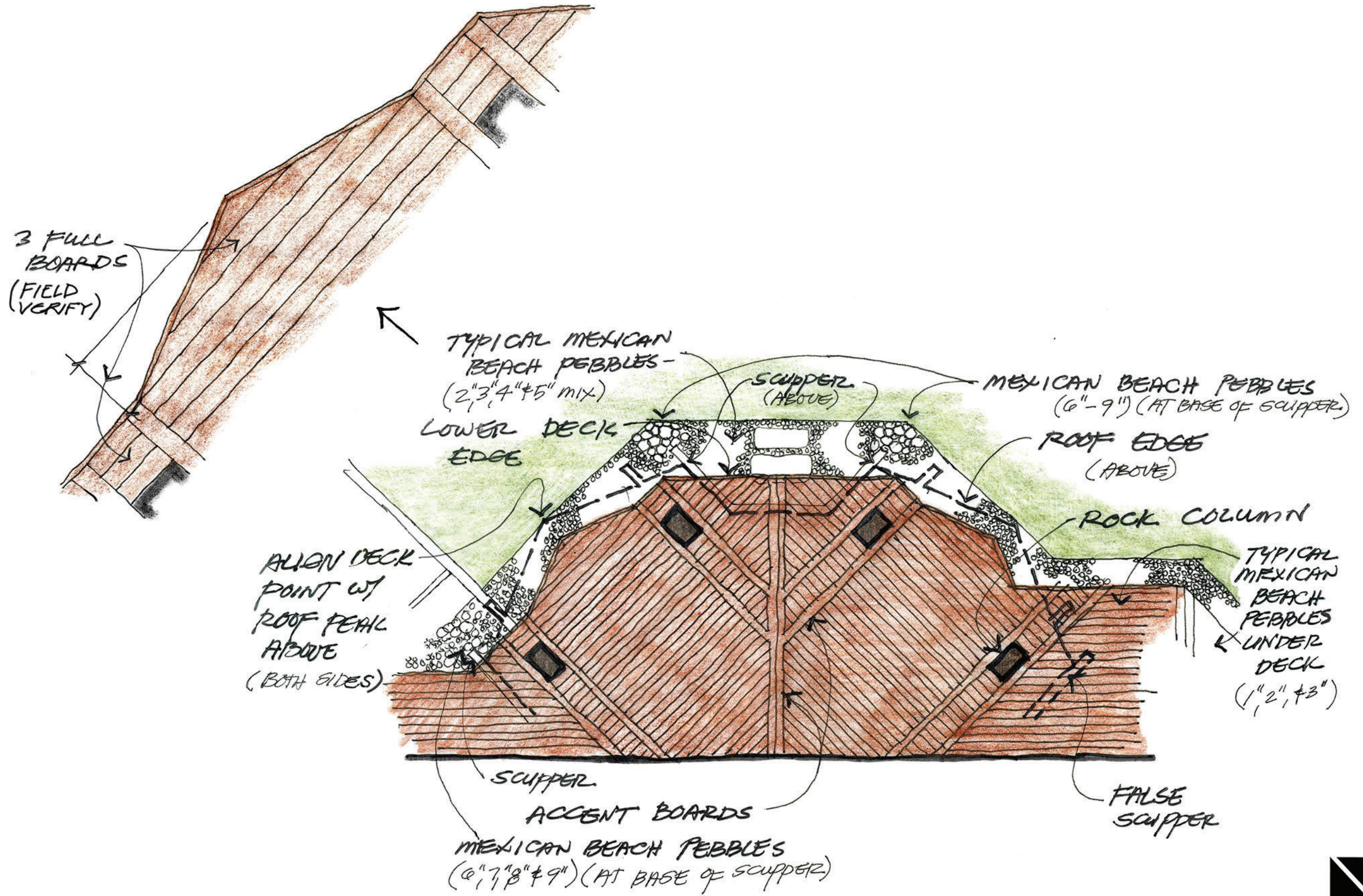

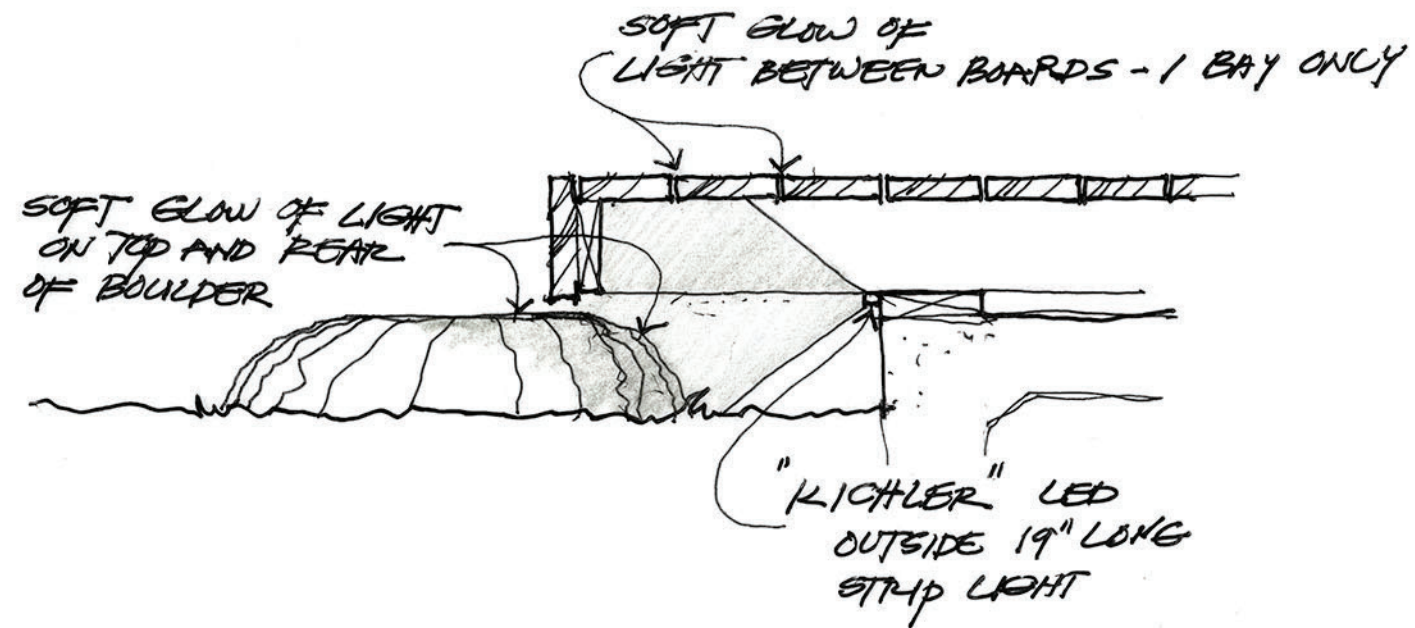
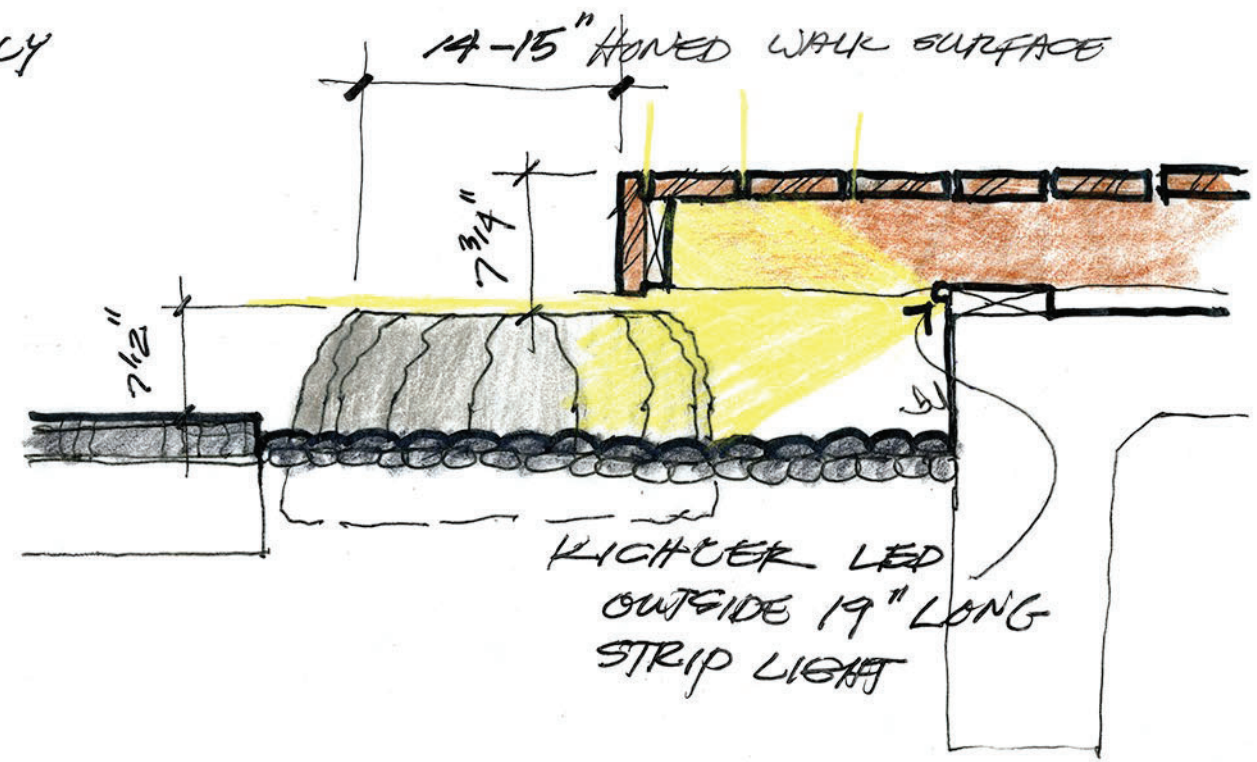
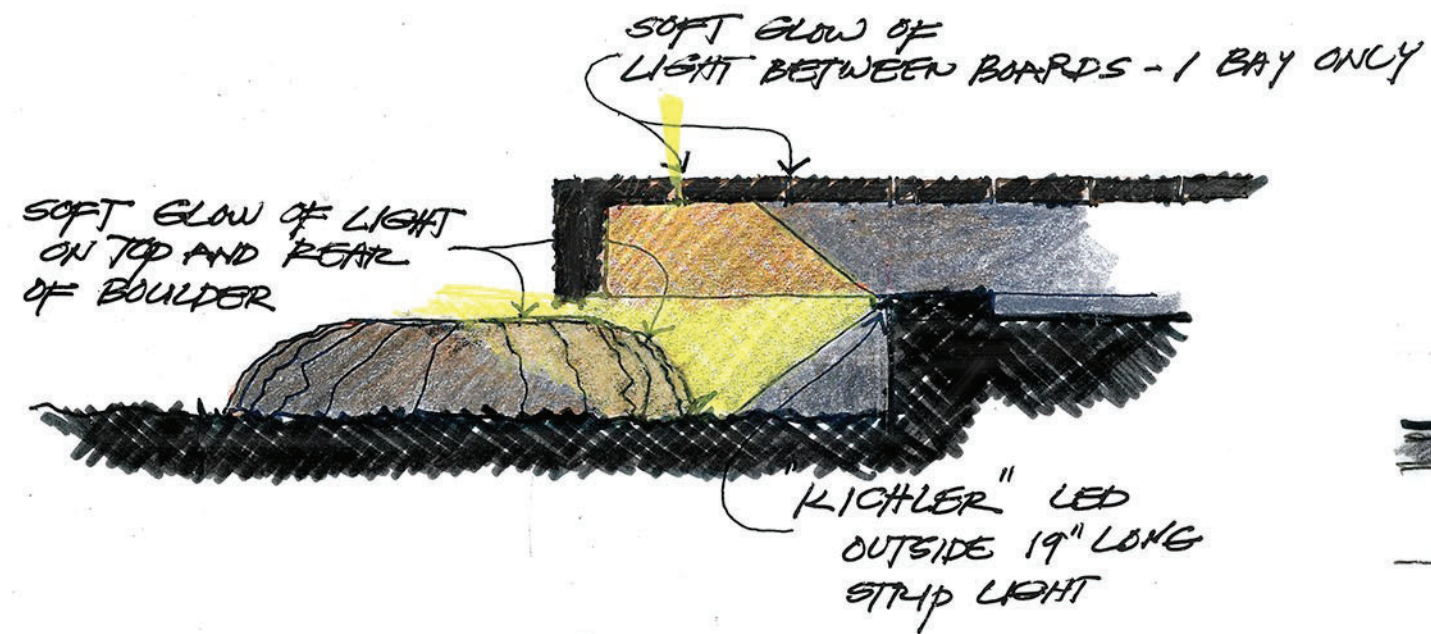

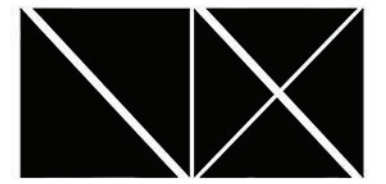
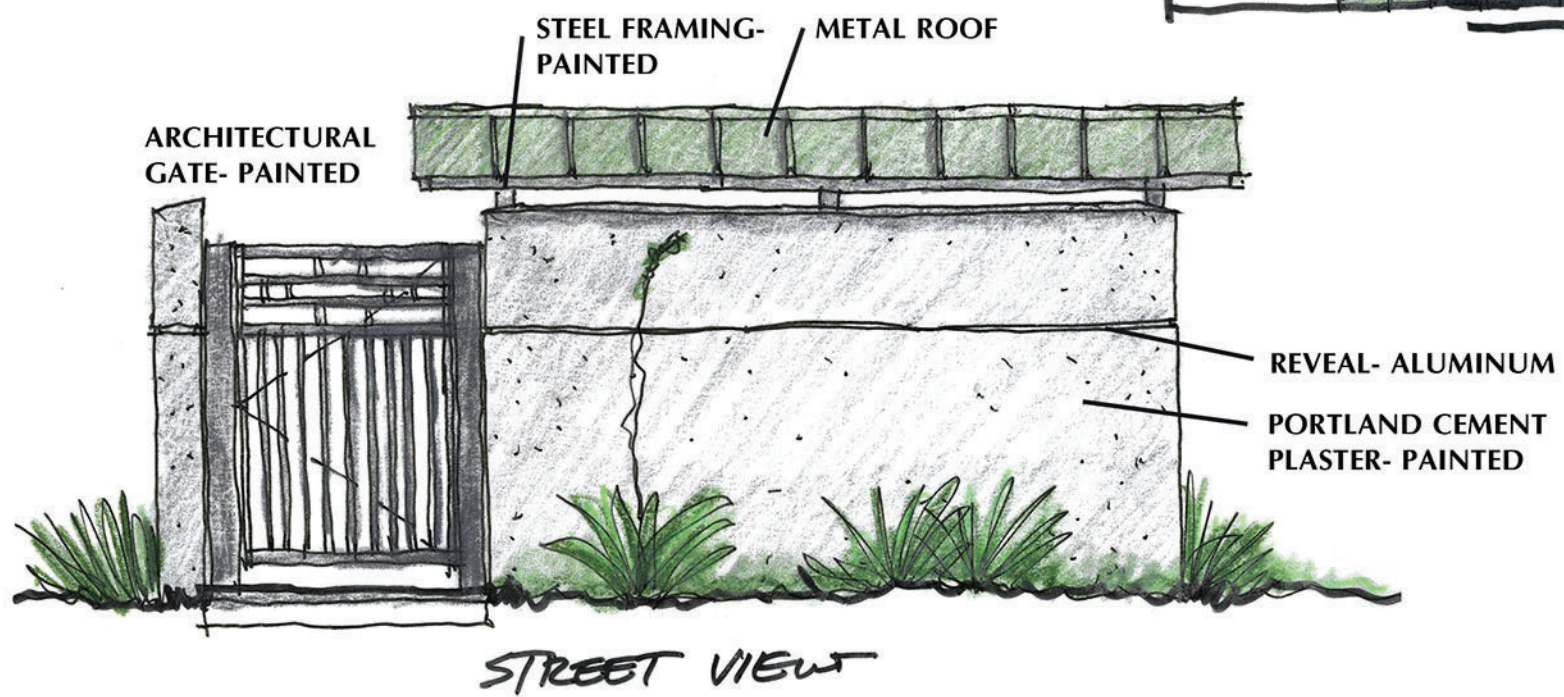
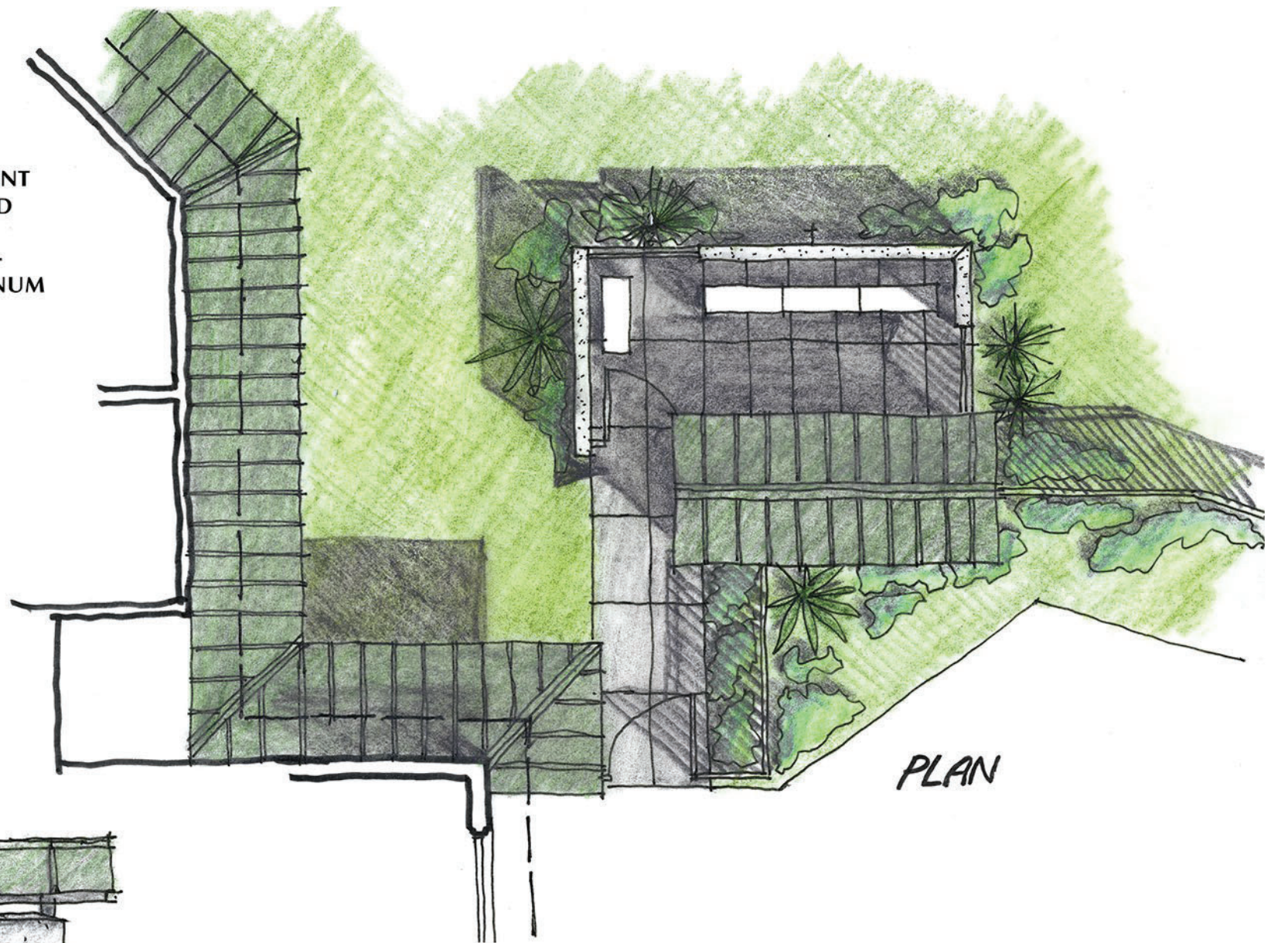
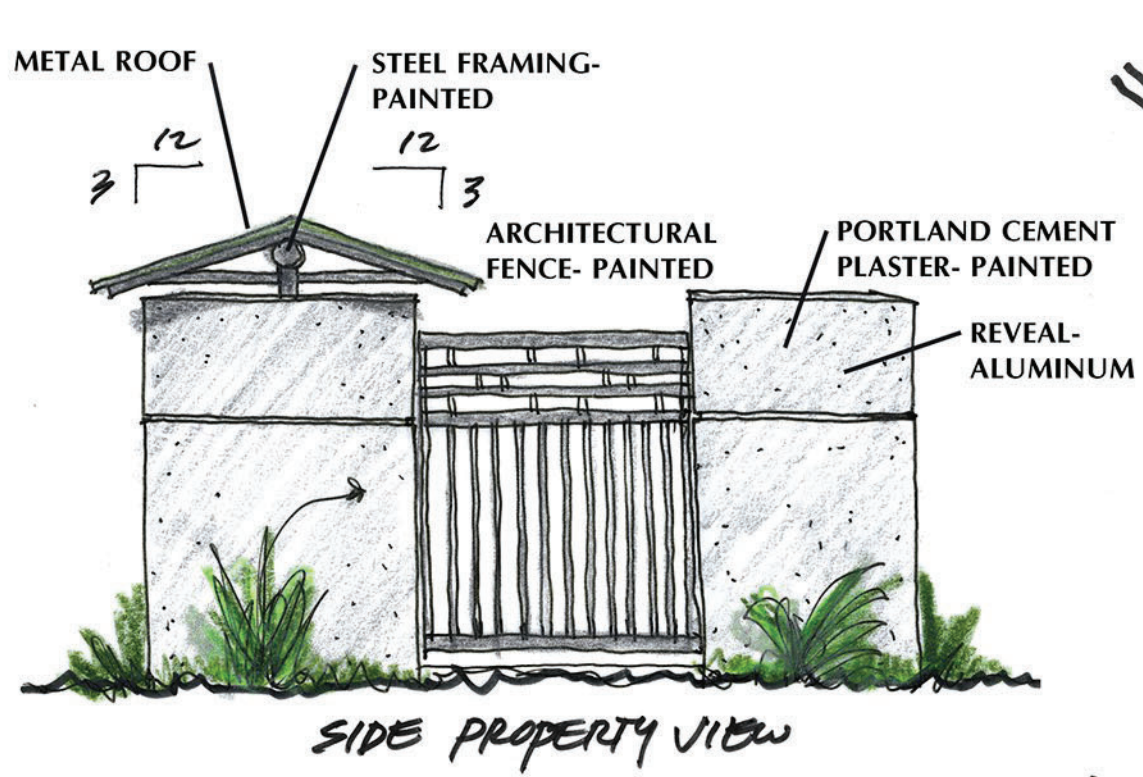

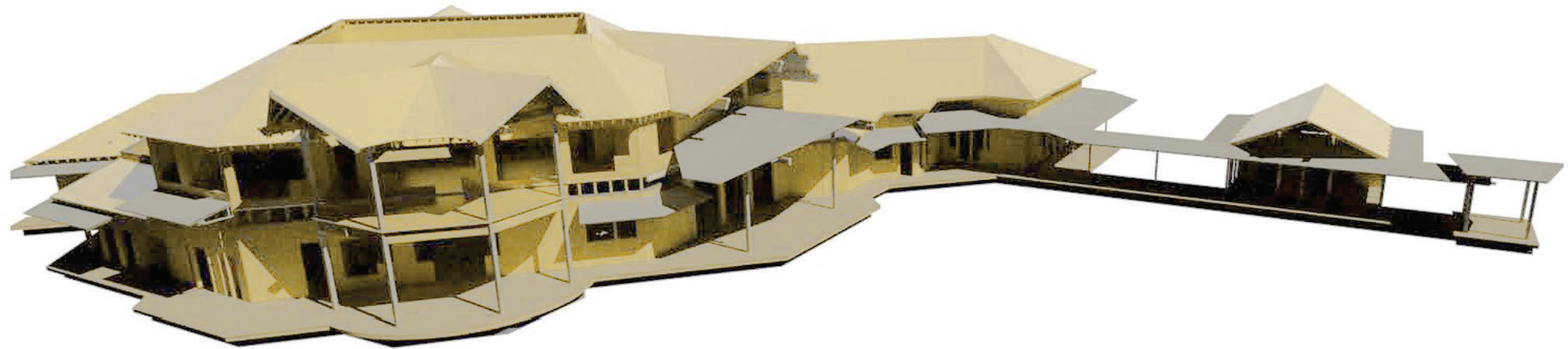

NIX GROUP
ARCHITECTS

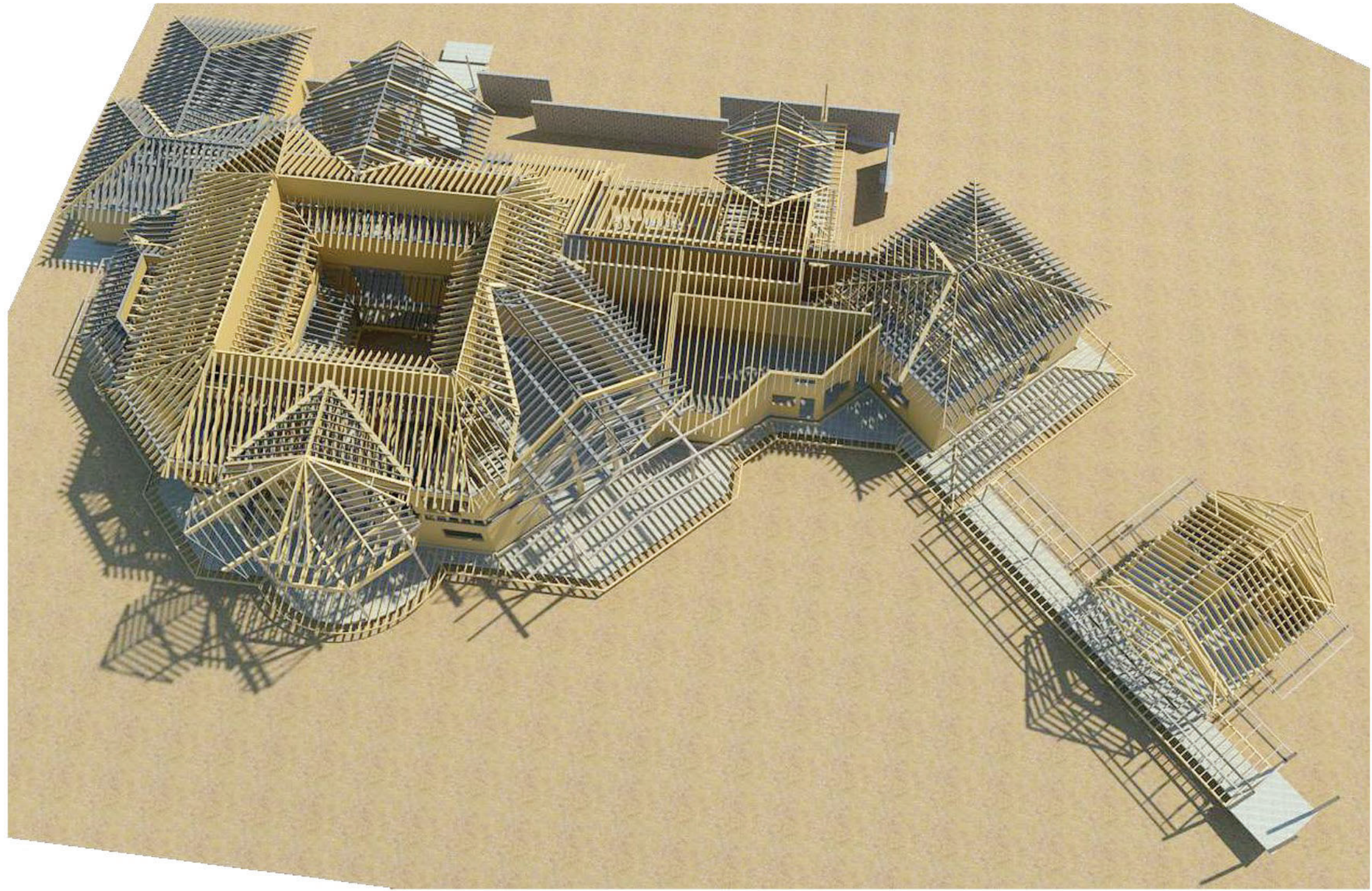

NIX GROUP
ARCHITECTS

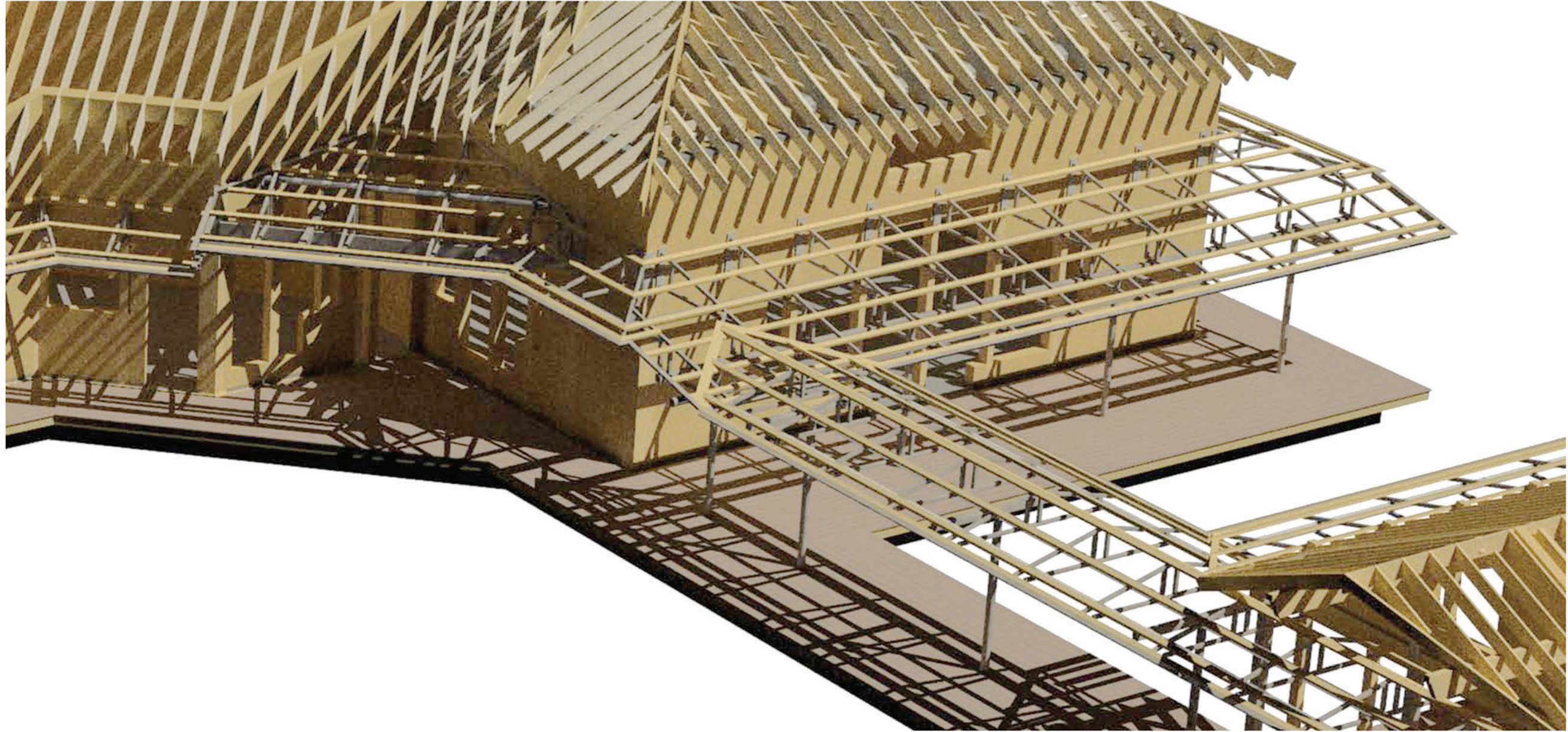

NIX GROUP
ARCHITECTS

